

| (SYMBOL) | (PARTS CODE) | (DESCRIPTION) | (QTY) | (LIST PRICE) |
|----------|--------------|---|-------|--------------|
| R061 | BRPB183324Z | RESISTOR:CARBON AXIAL LEAD 3.3K 1/8W J | 1 | \$ 0.50 |
| R062 | BRPA611034Z | RESISTOR:CARBON AX TS 26 10K 1/6W J TAPING | 1 | \$ 0.04 |
| R063 | BRPA613934Z | RESISTOR:CARBON AX TS 26 39K 1/6W J TAPING | 1 | \$ 0.04 |
| R064 | BRPA613324Z | RESISTOR:CARBON AX TS 26 3.3K 1/6W J TAPING | 1 | \$ 0.04 |
| R065 | BRPA611024Z | RESISTOR:CARBON AX TS 26 1K 1/6W J TAPING | 1 | \$ 0.04 |
| R066 | BRPA611034Z | RESISTOR:CARBON AX TS 26 10K 1/6W J TAPING | 1 | \$ 0.04 |
| R067 | BRPA611024Z | RESISTOR:CARBON AX TS 26 1K 1/6W J TAPING | 1 | \$ 0.04 |
| R068 | BRPA613324Z | RESISTOR:CARBON AX TS 26 3.3K 1/6W J TAPING | 1 | \$ 0.04 |
| R069 | BRPA611024Z | RESISTOR:CARBON AX TS 26 1K 1/6W J TAPING | 1 | \$ 0.04 |
| R070 | BRPA613924Z | RESISTOR:CARBON AX TS 26 3.9K 1/6W J TAPING | 1 | \$ 0.04 |
| R071 | BRPA612224Z | RESISTOR:CARBON AX TS 26 2.2K 1/6W J TAPING | 1 | \$ 0.04 |
| R072 | BRPA611024Z | RESISTOR:CARBON AX TS 26 1K 1/6W J TAPING | 1 | \$ 0.04 |
| R073 | BRPA613314Z | RESISTOR:CARBON AX TS 26 330 1/6W J TAPING | 1 | \$ 0.04 |
| R074 | BRPA611514Z | RESISTOR:CARBON AX TS 26 150 1/6W J TAPING | 1 | \$ 0.04 |
| R075 | BRPA611014Z | RESISTOR:CARBON AX TS 26 100 1/6W J TAPING | 1 | \$ 0.04 |
| R076 | BRPA611544Z | RESISTOR:CARBON AX TS 26 150K 1/6W J TAPING | 1 | \$ 0.04 |
| R077 | BRPA612744Z | RESISTOR:CARBON AX TS 26 270K 1/6W J TAPING | 1 | \$ 0.04 |
| R078 | BRPA611554Z | RESISTOR:CARBON AX TS 26 1.5M 1/6W J TAPING | 1 | \$ 0.04 |
| R079 | BRPA613924Z | RESISTOR:CARBON AX TS 26 3.9K 1/6W J TAPING | 1 | \$ 0.04 |
| R080 | BRPA611044Z | RESISTOR:CARBON AX TS 26 100K 1/6W J TAPING | 1 | \$ 0.04 |
| R081 | BRPA618234Z | RESISTOR:CARBON AX TS 26 82K 1/6W J TAPING | 1 | \$ 0.04 |
| R082 | BRPA616834Z | RESISTOR:CARBON AX TS 26 68K 1/6W J TAPING | 1 | \$ 0.04 |
| R083 | BRPA612734Z | RESISTOR:CARBON AX TS 26 27K 1/6W J TAPING | 1 | \$ 0.04 |
| R084 | BRPA611034Z | RESISTOR:CARBON AX TS 26 10K 1/6W J TAPING | 1 | \$ 0.04 |
| R085 | BRPA614744Z | RESISTOR:CARBON AX TS 26 470K 1/6W J TAPING | 1 | \$ 0.04 |
| R086 | BRPA611014Z | RESISTOR:CARBON AX TS 26 100 1/6W J TAPING | 1 | \$ 0.04 |
| R087 | BRPA611034Z | RESISTOR:CARBON AX TS 26 10K 1/6W J TAPING | 1 | \$ 0.04 |
| R088 | BRPA612734Z | RESISTOR:CARBON AX TS 26 27K 1/6W J TAPING | 1 | \$ 0.04 |
| R089 | BRPA614734Z | RESISTOR:CARBON AX TS 26 47K 1/6W J TAPING | 1 | \$ 0.04 |
| R090 | BRPA611034Z | RESISTOR:CARBON AX TS 26 10K 1/6W J TAPING | 1 | \$ 0.04 |
| R091 | BRPA614734Z | RESISTOR:CARBON AX TS 26 47K 1/6W J TAPING | 1 | \$ 0.04 |
| R092 | BRPA615604Z | RESISTOR:CARBON AX TS 26 56 1/6W J TAPING | 1 | \$ 0.04 |
| R093 | BRPA612224Z | RESISTOR:CARBON AX TS 26 2.2K 1/6W J TAPING | 1 | \$ 0.04 |
| R094 | BRPA614724Z | RESISTOR:CARBON AX TS 26 4.7K 1/6W J TAPING | 1 | \$ 0.04 |
| R095 | | | 1 | \$ 0.04 |
| R097 | BRPA613324Z | RESISTOR:CARBON AX TS 26 3.3K 1/6W J TAPING | 1 | \$ 0.04 |
| R099 | BRPA615614Z | RESISTOR:CARBON AX TS 26 560 1/6W J TAPING | 1 | \$ 0.04 |
| R100 | BRPB183324Z | RESISTOR:CARBON AXIAL LEAD 3.3K 1/8W J | 1 | \$ 0.50 |
| R102 | BRPA611524Z | RESISTOR:CARBON AX TS 26 1.5K 1/6W J TAPING | 1 | \$ 0.04 |
| R103 | BRPA611014Z | RESISTOR:CARBON AX TS 26 100 1/6W J TAPING | 1 | \$ 0.04 |
| R104 | BRPA614744Z | RESISTOR:CARBON AX TS 26 470K 1/6W J TAPING | 1 | \$ 0.04 |
| R105 | BRPA614714Z | RESISTOR:CARBON AX TS 26 470 1/6W J TAPING | 1 | \$ 0.04 |
| R106 | BRPA615624Z | RESISTOR:CARBON AX TS 26 5.6K 1/6W J TAPING | 1 | \$ 0.04 |
| R107 | BRPA612234Z | RESISTOR:CARBON AX TS 26 22K 1/6W J TAPING | 1 | \$ 0.04 |

| (SYMBOL) | (PARTS CODE) | (DESCRIPTION) | (QTY) | (LIST PRICE) |
|----------|--------------|---|-------|--------------|
| R108 | BRPA614714Z | RESISTOR:CARBON AX TS 26 470 1/6W J TAPING | 1 | \$ 0.04 |
| R109 | BRPA611524Z | RESISTOR:CARBON AX TS 26 1.5K 1/6W J TAPING | 1 | \$ 0.04 |
| R110 | BRPA612224Z | RESISTOR:CARBON AX TS 26 2.2K 1/6W J TAPING | 1 | \$ 0.04 |
| R111 | | | 1 | \$ 0.04 |
| R112 | BRPA611024Z | RESISTOR:CARBON AX TS 26 1K 1/6W J TAPING | 1 | \$ 0.04 |
| R113 | BRPA611034Z | RESISTOR:CARBON AX TS 26 10K 1/6W J TAPING | 1 | \$ 0.04 |
| R114 | BRPA612224Z | RESISTOR:CARBON AX TS 26 2.2K 1/6W J TAPING | 1 | \$ 0.04 |
| R115 | BRPA611014Z | RESISTOR:CARBON AX TS 26 100 1/6W J TAPING | 1 | \$ 0.04 |
| R116 | BRPA614714Z | RESISTOR:CARBON AX TS 26 470 1/6W J TAPING | 1 | \$ 0.04 |
| R117 | BRPB181834Z | RESISTOR:CARBON AXIAL LEAD 18K 1/8W J | 1 | \$ 0.03 |
| R118 | BRPA611524Z | RESISTOR:CARBON AX TS 26 1.5K 1/6W J TAPING | 1 | \$ 0.04 |
| R119 | BRPA615624Z | RESISTOR:CARBON AX TS 26 5.6K 1/6W J TAPING | 1 | \$ 0.04 |
| R120 | BRPA611524Z | RESISTOR:CARBON AX TS 26 1.5K 1/6W J TAPING | 1 | \$ 0.04 |
| R121 | BRPA613324Z | RESISTOR:CARBON AX TS 26 3.3K 1/6W J TAPING | 1 | \$ 0.04 |
| R122 | | | 1 | \$ 0.04 |
| R123 | BRPA618214Z | RESISTOR:CARBON AX TS 26 820 1/6W J TAPING | 1 | \$ 0.04 |
| R124 | BRPB181024Z | RESISTOR:CARBON AXIAL LEAD 1K 1/8W J | 1 | \$ 0.50 |
| R125 | BRPA611034Z | RESISTOR:CARBON AX TS 26 10K 1/6W J TAPING | 1 | \$ 0.04 |
| R126 | BRPA614734Z | RESISTOR:CARBON AX TS 26 47K 1/6W J TAPING | 1 | \$ 0.04 |
| R127 | | | 1 | \$ 0.04 |
| R128 | BRPA614724Z | RESISTOR:CARBON AX TS 26 4.7K 1/6W J TAPING | 1 | \$ 0.04 |
| R129 | BRPA614734Z | RESISTOR:CARBON AX TS 26 47K 1/6W J TAPING | 1 | \$ 0.04 |
| R130 | BRPA612224Z | RESISTOR:CARBON AX TS 26 2.2K 1/6W J TAPING | 1 | \$ 0.04 |
| R131 | BRPA614734Z | RESISTOR:CARBON AX TS 26 47K 1/6W J TAPING | 1 | \$ 0.04 |
| R132 | BRPA611514Z | RESISTOR:CARBON AX TS 26 150 1/6W J TAPING | 1 | \$ 0.04 |
| R133 | BRPA614724Z | RESISTOR:CARBON AX TS 26 4.7K 1/6W J TAPING | 1 | \$ 0.04 |
| R134 | | | 1 | \$ 0.04 |
| R135 | BRPA612244Z | RESISTOR:CARBON AX TS 26 220K 1/6W J TAPING | 1 | \$ 0.04 |
| R136 | BRPA614734Z | RESISTOR:CARBON AX TS 26 47K 1/6W J TAPING | 1 | \$ 0.04 |
| R137 | BRPA613334Z | RESISTOR:CARBON AX TS 26 33K 1/6W J TAPING | 1 | \$ 0.04 |
| R138 | BRPA614724Z | RESISTOR:CARBON AX TS 26 4.7K 1/6W J TAPING | 1 | \$ 0.04 |
| R139 | BRPA618224Z | RESISTOR:CARBON AX TS 26 8.2K 1/6W J TAPING | 1 | \$ 0.04 |
| R140 | BRPA615614Z | RESISTOR:CARBON AX TS 26 560 1/6W J TAPING | 1 | \$ 0.04 |
| R142 | BRPB181834Z | RESISTOR:CARBON AXIAL LEAD 18K 1/8W J | 1 | \$ 0.03 |
| R143 | BRPA611094Z | RESISTOR:CARBON AX TS 26 1 1/6W J TAPING | 1 | \$ 0.04 |
| R144 | BRPA611044Z | RESISTOR:CARBON AX TS 26 100K 1/6W J TAPING | 1 | \$ 0.04 |
| R145 | BRPA611814Z | RESISTOR:CARBON AX TS 26 180 1/6W J TAPING | 1 | \$ 0.04 |
| R146 | BRPB182734Z | RESISTOR:CARBON AXIAL LEAD 27K 1/8W J | 1 | \$ 0.50 |
| R147 | BRPA612234Z | RESISTOR:CARBON AX TS 26 22K 1/6W J TAPING | 1 | \$ 0.04 |
| R150 | BRPA611234Z | RESISTOR:CARBON AX TS 26 12K 1/6W J TAPING | 1 | \$ 0.04 |
| R153 | BRPA613304Z | RESISTOR:CARBON AX TS 26 33 1/6W J TAPING | 1 | \$ 0.04 |
| R155 | BRPA611034Z | RESISTOR:CARBON AX TS 26 10K 1/6W J TAPING | 1 | \$ 0.04 |
| R156 | BRPB183324Z | RESISTOR:CARBON AXIAL LEAD 3.3K 1/8W J | 1 | \$ 0.50 |
| R157 | BRPA611004Z | RESISTOR:CARBON AX TS 26 10 1/6W J TAPING | 1 | \$ 0.04 |

| (SYMBOL) | (PARTS CODE) | (DESCRIPTION) | (QTY) | (LIST PRICE) |
|----------|--------------|--|-------|--------------|
| R158 | BRPB128204Z | RESISTOR:CARBON AXIAL LEAD 82 1/2W J | 1 | \$ 0.07 |
| R159 | BRPA613314Z | RESISTOR:CARBON AX TS 26 330 1/6W J TAPING | 1 | \$ 0.04 |
| R160 | BRPA611024Z | RESISTOR:CARBON AX TS 26 1K 1/6W J TAPING | 1 | \$ 0.04 |
| R161 | BRPA614704Z | RESISTOR:CARBON AX TS 26 47 1/6W J TAPING | 1 | \$ 0.04 |
| R162 | BRPA611014Z | RESISTOR:CARBON AX TS 26 100 1/6W J TAPING | 1 | \$ 0.04 |
| R163 | BRPA611204Z | RESISTOR:CARBON AX TS 26 12 1/6W J TAPING | 1 | \$ 0.04 |
| R164 | BRPA611514Z | RESISTOR:CARBON AX TS 26 150 1/6W J TAPING | 1 | \$ 0.04 |
| R165 | BRPA613314Z | RESISTOR:CARBON AX TS 26 330 1/6W J TAPING | 1 | \$ 0.04 |
| R166 | BRPA611524Z | RESISTOR:CARBON AX TS 26 1.5K 1/6W J TAPING | 1 | \$ 0.04 |
| R167 | BRPA611014Z | RESISTOR:CARBON AX TS 26 100 1/6W J TAPING | 1 | \$ 0.04 |
| R168 | BRPA611024Z | RESISTOR:CARBON AX TS 26 1K 1/6W J TAPING | 1 | \$ 0.04 |
| R169 | BRPA611524Z | RESISTOR:CARBON AX TS 26 1.5K 1/6W J TAPING | 1 | \$ 0.04 |
| R170 | BRPA611024Z | RESISTOR:CARBON AX TS 26 1K 1/6W J TAPING | 1 | \$ 0.04 |
| R171 | BRPA611014Z | RESISTOR:CARBON AX TS 26 100 1/6W J TAPING | 1 | \$ 0.04 |
| R172 | | | 1 | \$ 0.04 |
| R173 | BRPA613324Z | RESISTOR:CARBON AX TS 26 3.3K 1/6W J TAPING | 1 | \$ 0.04 |
| R174 | BRPA615634Z | RESISTOR:CARBON AX TS 26 56K 1/6W J TAPING | 1 | \$ 0.04 |
| R175 | BRPA613304Z | RESISTOR:CARBON AX TS 26 33 1/6W J TAPING | 1 | \$ 0.04 |
| R176 | BRPA614714Z | RESISTOR:CARBON AX TS 26 470 1/6W J TAPING | 1 | \$ 0.04 |
| R177 | BRPA611524Z | RESISTOR:CARBON AX TS 26 1.5K 1/6W J TAPING | 1 | \$ 0.04 |
| R178 | BRPA614734Z | RESISTOR:CARBON AX TS 26 47K 1/6W J TAPING | 1 | \$ 0.04 |
| R180 | BRPA614704Z | RESISTOR:CARBON AX TS 26 47 1/6W J TAPING | 1 | \$ 0.04 |
| R181 | BRPA611524Z | RESISTOR:CARBON AX TS 26 1.5K 1/6W J TAPING | 1 | \$ 0.04 |
| R182 | BRPB182214Z | RESISTOR:CARBON AXIAL LEAD 220 1/8W J | 1 | \$ 0.50 |
| R183 | BRPA611024Z | RESISTOR:CARBON AX TS 26 1K 1/6W J TAPING | 1 | \$ 0.04 |
| R184 | BRPA612224Z | RESISTOR:CARBON AX TS 26 2.2K 1/6W J TAPING | 1 | \$ 0.04 |
| R185 | BRPA611524Z | RESISTOR:CARBON AX TS 26 1.5K 1/6W J TAPING | 1 | \$ 0.04 |
| R186 | BRPA614734Z | RESISTOR:CARBON AX TS 26 47K 1/6W J TAPING | 1 | \$ 0.04 |
| R187 | BRPA611034Z | RESISTOR:CARBON AX TS 26 10K 1/6W J TAPING | 1 | \$ 0.04 |
| R188 | | | 1 | \$ 0.04 |
| R189 | | | 1 | \$ 0.04 |
| R190 | BRPA613334Z | RESISTOR:CARBON AX TS 26 33K 1/6W J TAPING | 1 | \$ 0.04 |
| R192 | BRPA613324Z | RESISTOR:CARBON AX TS 26 3.3K 1/6W J TAPING | 1 | \$ 0.04 |
| R193 | BRPA611024Z | RESISTOR:CARBON AX TS 26 1K 1/6W J TAPING | 1 | \$ 0.04 |
| R194 | | AX TS 4.7K 1/6W TAPING | 1 | \$ 0.50 |
| R195 | BRPA614724Z | RESISTOR:CARBON AX TS 26 4.7K 1/6W J TAPING | 1 | \$ 0.04 |
| R198 | BRPA612234Z | RESISTOR:CARBON AX TS 26 22K 1/6W J TAPING | 1 | \$ 0.04 |
| R201 | BRFD181034Z | RESISTOR:CARBON MELF CHIP 10K 1/8W J TAPING | 1 | \$ 0.05 |
| R202 | BRFD182214Z | RESISTOR:CARBON MELF CHIP 220 1/8W J TAPING | 1 | \$ 0.05 |
| R203 | BRFD183334Z | RESISTOR:CARBON MELF CHIP 33K 1/8W J TAPING | 1 | \$ 0.05 |
| R204 | BRFD186814Z | RESISTOR:CARBON MELF CHIP 680 1/8W J TAPING | 1 | \$ 0.05 |
| R205 | BRFD181014Z | RESISTOR:CARBON MELF CHIP 100 1/8W J TAPING | 1 | \$ 0.05 |
| R206 | BRFD184734Z | RESISTOR:CARBON MELF CHIP 47K 1/8W J TAPING | 1 | \$ 0.05 |
| R207 | BRFD181524Z | RESISTOR:CARBON MELF CHIP 1.5K 1/8W J TAPING | 1 | \$ 0.05 |

| (SYMBOL) | (PARTS CODE) | (DESCRIPTION) | (QTY) | (LIST PRICE) |
|----------|--------------|--|-------|--------------|
| R208 | BRFD183314Z | RESISTOR:CARBON MELF CHIP 330 1/8W J TAPING | 1 | \$ 0.05 |
| R209 | | | 1 | \$ 0.05 |
| R211 | BRFD186804Z | RESISTOR:CARBON MELF CHIP 68 1/8W J TAPING | 1 | \$ 0.05 |
| R212 | BRPB181044Z | RESISTOR:CARBON AXIAL LEAD 100K 1/8W J | 1 | \$ 0.50 |
| R213 | BRZY0025001 | JUMPER CHIP RZ-025 MRD18S TAPING | 1 | \$ 0.07 |
| R214 | BRFD181034Z | RESISTOR:CARBON MELF CHIP 10K 1/8W J TAPING | 1 | \$ 0.05 |
| R215 | | | 1 | \$ 0.05 |
| R216 | BRFD184744Z | RESISTOR:CARBON MELF CHIP 470K 1/8W J TAPING | 1 | \$ 0.05 |
| R217 | BRFD181034Z | RESISTOR:CARBON MELF CHIP 10K 1/8W J TAPING | 1 | \$ 0.05 |
| R218 | BRFD183324Z | RESISTOR:CARBON MELF CHIP 3.3K 1/8W J TAPING | 1 | \$ 0.05 |
| R219 | BRFD183314Z | RESISTOR:CARBON MELF CHIP 330 1/8W J TAPING | 1 | \$ 0.05 |
| R221 | BRFD181034Z | RESISTOR:CARBON MELF CHIP 10K 1/8W J TAPING | 1 | \$ 0.05 |
| R222 | BRFD183324Z | RESISTOR:CARBON MELF CHIP 3.3K 1/8W J TAPING | 1 | \$ 0.05 |
| R223 | BRZY0025001 | JUMPER CHIP RZ-025 MRD18S TAPING | 1 | \$ 0.07 |
| R301 | BRFC181064Z | RESISTOR:CARBON FIXED CHIP 10M 1/8W J TAPING | 1 | \$ 0.05 |
| R302 | BRFD181534Z | RESISTOR:CARBON MELF CHIP 15K 1/8W J TAPING | 1 | \$ 0.05 |
| R303 | | | 1 | \$ 0.05 |
| R304 | BRPA611034Z | RESISTOR:CARBON AX TS 26 10K 1/6W J TAPING | 1 | \$ 0.04 |
| R305 | BRFD181034Z | RESISTOR:CARBON MELF CHIP 10K 1/8W J TAPING | 1 | \$ 0.05 |
| R306 | | | 1 | \$ 0.05 |
| R307 | BRFD181024Z | RESISTOR:CARBON MELF CHIP 1K 1/8W J TAPING | 1 | \$ 0.05 |
| R308 | BRFD181034Z | RESISTOR:CARBON MELF CHIP 10K 1/8W J TAPING | 1 | \$ 0.05 |
| R309 | BRPB183324Z | RESISTOR:CARBON AXIAL LEAD 3.3K 1/8W J | 1 | \$ 0.50 |
| R310 | BRFD183314Z | RESISTOR:CARBON MELF CHIP 330 1/8W J TAPING | 1 | \$ 0.05 |
| R311 | BRFD181034Z | RESISTOR:CARBON MELF CHIP 10K 1/8W J TAPING | 1 | \$ 0.05 |
| R312 | | | 1 | \$ 0.05 |
| R313 | BRFD181534Z | RESISTOR:CARBON MELF CHIP 15K 1/8W J TAPING | 1 | \$ 0.05 |
| R314 | BRFD186814Z | RESISTOR:CARBON MELF CHIP 680 1/8W J TAPING | 1 | \$ 0.05 |
| R315 | BRFD181024Z | RESISTOR:CARBON MELF CHIP 1K 1/8W J TAPING | 1 | \$ 0.05 |
| R316 | BRFD181234Z | RESISTOR:CARBON MELF CHIP 12K 1/8W J TAPING | 1 | \$ 0.05 |
| R317 | BRPB181034Z | RESISTOR:CARBON AXIAL LEAD 10K 1/8W J | 1 | \$ 0.03 |
| R318 | BRFD181024Z | RESISTOR:CARBON MELF CHIP 1K 1/8W J TAPING | 1 | \$ 0.05 |
| R319 | BRFD181014Z | RESISTOR:CARBON MELF CHIP 100 1/8W J TAPING | 1 | \$ 0.05 |
| R320 | BRFD183314Z | RESISTOR:CARBON MELF CHIP 330 1/8W J TAPING | 1 | \$ 0.05 |
| R321 | BRPB183314Z | RESISTOR:CARBON AXIAL LEAD 330 1/8W J | 1 | \$ 0.50 |
| R322 | BRFD181024Z | RESISTOR:CARBON MELF CHIP 1K 1/8W J TAPING | 1 | \$ 0.05 |
| R323 | BRPB181544Z | RESISTOR:CARBON AXIAL LEAD 150K 1/8W J | 1 | \$ 0.03 |
| R324 | BRFD181034Z | RESISTOR:CARBON MELF CHIP 10K 1/8W J TAPING | 1 | \$ 0.05 |
| R325 | BRZY0025001 | JUMPER CHIP RZ-025 MRD18S TAPING | 1 | \$ 0.07 |
| R326 | BRFD181024Z | RESISTOR:CARBON MELF CHIP 1K 1/8W J TAPING | 1 | \$ 0.05 |
| R327 | BRFD182234Z | RESISTOR:CARBON MELF CHIP 22K 1/8W J TAPING | 1 | \$ 0.05 |
| R328 | BRPB181024Z | RESISTOR:CARBON AXIAL LEAD 1K 1/8W J | 1 | \$ 0.50 |
| R329 | BRFD181024Z | RESISTOR:CARBON MELF CHIP 1K 1/8W J TAPING | 1 | \$ 0.05 |
| R331 | BRFD181524Z | RESISTOR:CARBON MELF CHIP 1.5K 1/8W J TAPING | 1 | \$ 0.05 |

| (SYMBOL) | (PARTS CODE) | (DESCRIPTION) | (QTY) | (LIST PRICE) |
|----------|--------------|--|-------|--------------|
| R332 | BRFD181024Z | RESISTOR:CARBON MELF CHIP 1K 1/8W J TAPING | 1 | \$ 0.05 |
| R333 | BRFD181034Z | RESISTOR:CARBON MELF CHIP 10K 1/8W J TAPING | 1 | \$ 0.05 |
| R334 | | | 1 | \$ 0.05 |
| R335 | BRFD183324Z | RESISTOR:CARBON MELF CHIP 3.3K 1/8W J TAPING | 1 | \$ 0.05 |
| R336 | BRFD181034Z | RESISTOR:CARBON MELF CHIP 10K 1/8W J TAPING | 1 | \$ 0.05 |
| R337 | | | 1 | \$ 0.05 |
| R338 | BRFD182234Z | RESISTOR:CARBON MELF CHIP 22K 1/8W J TAPING | 1 | \$ 0.05 |
| R339 | BRFD181814Z | RESISTOR:CARBON MELF CHIP 180 1/8W J TAPING | 1 | \$ 0.05 |
| R341 | | | 1 | \$ 0.05 |
| R342 | BRFD183324Z | RESISTOR:CARBON MELF CHIP 3.3K 1/8W J TAPING | 1 | \$ 0.05 |
| R343 | BRFD182214Z | RESISTOR:CARBON MELF CHIP 220 1/8W J TAPING | 1 | \$ 0.05 |
| R344 | BRFD184724Z | RESISTOR:CARBON MELF CHIP 4.7K 1/8W J TAPING | 1 | \$ 0.05 |
| R345 | BRFD185624Z | RESISTOR:CARBON MELF CHIP 5.6K 1/8W J TAPING | 1 | \$ 0.05 |
| R346 | BRFD186814Z | RESISTOR:CARBON MELF CHIP 680 1/8W J TAPING | 1 | \$ 0.05 |
| R347 | BRPA611524Z | RESISTOR:CARBON AX TS 26 1.5K 1/6W J TAPING | 1 | \$ 0.04 |
| R348 | BRFD183324Z | RESISTOR:CARBON MELF CHIP 3.3K 1/8W J TAPING | 1 | \$ 0.05 |
| R349 | BRFD181814Z | RESISTOR:CARBON MELF CHIP 180 1/8W J TAPING | 1 | \$ 0.05 |
| R351 | BRFD181524Z | RESISTOR:CARBON MELF CHIP 1.5K 1/8W J TAPING | 1 | \$ 0.05 |
| R352 | BRFD181814Z | RESISTOR:CARBON MELF CHIP 180 1/8W J TAPING | 1 | \$ 0.05 |
| R353 | BRFD183324Z | RESISTOR:CARBON MELF CHIP 3.3K 1/8W J TAPING | 1 | \$ 0.05 |
| R354 | BRPB184724Z | RESISTOR:CARBON AXIAL LEAD 4.7K 1/8W J | 1 | \$ 0.50 |
| R355 | BRZY0025001 | JUMPER CHIP RZ-025 MRD18S TAPING | 1 | \$ 0.07 |
| R356 | BRPA611034Z | RESISTOR:CARBON AX TS 26 10K 1/6W J TAPING | 1 | \$ 0.04 |
| R357 | BRFD181034Z | RESISTOR:CARBON MELF CHIP 10K 1/8W J TAPING | 1 | \$ 0.05 |
| R358 | BRFD184724Z | RESISTOR:CARBON MELF CHIP 4.7K 1/8W J TAPING | 1 | \$ 0.05 |
| R359 | BRFD181224Z | RESISTOR:CARBON MELF CHIP 1.2K 1/8W J TAPING | 1 | \$ 0.05 |
| R360 | BRFD186834Z | RESISTOR:CARBON MELF CHIP 68K 1/8W J TAPING | 1 | \$ 0.05 |
| R361 | BRFD181224Z | RESISTOR:CARBON MELF CHIP 1.2K 1/8W J TAPING | 1 | \$ 0.05 |
| R362 | BRFD181034Z | RESISTOR:CARBON MELF CHIP 10K 1/8W J TAPING | 1 | \$ 0.05 |
| R363 | BRFD181024Z | RESISTOR:CARBON MELF CHIP 1K 1/8W J TAPING | 1 | \$ 0.05 |
| R364 | BRFD182734Z | RESISTOR:CARBON MELF CHIP 27K 1/8W J TAPING | 1 | \$ 0.05 |
| R365 | BRPA613934Z | RESISTOR:CARBON AX TS 26 39K 1/6W J TAPING | 1 | \$ 0.04 |
| R366 | BRFD183324Z | RESISTOR:CARBON MELF CHIP 3.3K 1/8W J TAPING | 1 | \$ 0.05 |
| R370 | BRFD181524Z | RESISTOR:CARBON MELF CHIP 1.5K 1/8W J TAPING | 1 | \$ 0.05 |
| R371 | BRFD182224Z | RESISTOR:CARBON MELF CHIP 2.2K 1/8W J TAPING | 1 | \$ 0.05 |
| R373 | BRFD184734Z | RESISTOR:CARBON MELF CHIP 47K 1/8W J TAPING | 1 | \$ 0.05 |
| R374 | BRFD181044Z | RESISTOR:CARBON MELF CHIP 100K 1/8W J TAPING | 1 | \$ 0.05 |
| R375 | BRFD181034Z | RESISTOR:CARBON MELF CHIP 10K 1/8W J TAPING | 1 | \$ 0.05 |
| R376 | | | 1 | \$ 0.05 |
| R377 | BRFD181024Z | RESISTOR:CARBON MELF CHIP 1K 1/8W J TAPING | 1 | \$ 0.05 |
| R378 | BRFD188234Z | RESISTOR:CARBON MELF CHIP 82K 1/8W J TAPING | 1 | \$ 0.05 |
| R379 | BRFD181044Z | RESISTOR:CARBON MELF CHIP 100K 1/8W J TAPING | 1 | \$ 0.05 |
| R381 | BRFD181034Z | RESISTOR:CARBON MELF CHIP 10K 1/8W J TAPING | 1 | \$ 0.05 |
| R382 | BRFD181034Z | RESISTOR:CARBON MELF CHIP 10K 1/8W J TAPING | 1 | \$ 0.05 |

| (SYMBOL) | (PARTS CODE) | (DESCRIPTION) | (QTY) | (LIST PRICE) |
|----------|--------------|--|-------|--------------|
| R383 | BRFD181034Z | RESISTOR:CARBON MELF CHIP 10K 1/8W J TAPING | 1 | \$ 0.05 |
| R384 | | | 1 | \$ 0.05 |
| R385 | BRFD181024Z | RESISTOR:CARBON MELF CHIP 1K 1/8W J TAPING | 1 | \$ 0.05 |
| R387 | | | 1 | \$ 0.05 |
| R392 | BRFD184724Z | RESISTOR:CARBON MELF CHIP 4.7K 1/8W J TAPING | 1 | \$ 0.05 |
| R393 | BRFD184714Z | RESISTOR:CARBON MELF CHIP 470 1/8W J TAPING | 1 | \$ 0.05 |
| R394 | BRFD186814Z | RESISTOR:CARBON MELF CHIP 680 1/8W J TAPING | 1 | \$ 0.05 |
| R395 | BRFD186824Z | RESISTOR:CARBON MELF CHIP 6.8K 1/8W J TAPING | 1 | \$ 0.05 |
| R396 | BRFD181824Z | RESISTOR:CARBON MELF CHIP 1.8K 1/8W J TAPING | 1 | \$ 0.05 |
| R402 | BRZY0025001 | JUMPER CHIP RZ-025 MRD18S TAPING | 1 | \$ 0.07 |
| R403 | | | 1 | \$ 0.07 |
| R405 | BRFD181024Z | RESISTOR:CARBON MELF CHIP 1K 1/8W J TAPING | 1 | \$ 0.05 |
| R409 | BRFD181004Z | RESISTOR:CARBON MELF CHIP 10 1/8W J TAPING | 1 | \$ 0.05 |
| R411 | BRFD182224Z | RESISTOR:CARBON MELF CHIP 2.2K 1/8W J TAPING | 1 | \$ 0.05 |
| R412 | | | 1 | \$ 0.05 |
| R413 | BRFD184734Z | RESISTOR:CARBON MELF CHIP 47K 1/8W J TAPING | 1 | \$ 0.05 |
| R414 | BRFD186834Z | RESISTOR:CARBON MELF CHIP 68K 1/8W J TAPING | 1 | \$ 0.05 |
| R415 | BRFD181014Z | RESISTOR:CARBON MELF CHIP 100 1/8W J TAPING | 1 | \$ 0.05 |
| R416 | BRFD181034Z | RESISTOR:CARBON MELF CHIP 10K 1/8W J TAPING | 1 | \$ 0.05 |
| R443 | BRFD181524Z | RESISTOR:CARBON MELF CHIP 1.5K 1/8W J TAPING | 1 | \$ 0.05 |
| R444 | BRFD181054Z | RESISTOR:CARBON MELF CHIP 1M 1/8W J TAPING | 1 | \$ 0.05 |
| R445 | BRFD181524Z | RESISTOR:CARBON MELF CHIP 1.5K 1/8W J TAPING | 1 | \$ 0.05 |
| R451 | BRFD181034Z | RESISTOR:CARBON MELF CHIP 10K 1/8W J TAPING | 1 | \$ 0.05 |
| R456 | | | 1 | \$ 0.05 |
| R457 | | | 1 | \$ 0.05 |
| R458 | | | 1 | \$ 0.05 |
| R459 | | | 1 | \$ 0.05 |
| R461 | | | 1 | \$ 0.05 |
| R462 | | | 1 | \$ 0.05 |
| R463 | | | 1 | \$ 0.05 |
| R464 | | | 1 | \$ 0.05 |
| R465 | | | 1 | \$ 0.05 |
| R466 | | | 1 | \$ 0.05 |
| R472 | BRFD181054Z | RESISTOR:CARBON MELF CHIP 1M 1/8W J TAPING | 1 | \$ 0.05 |
| R478 | BRFD181034Z | RESISTOR:CARBON MELF CHIP 10K 1/8W J TAPING | 1 | \$ 0.05 |
| R481 | | | 1 | \$ 0.05 |
| R482 | BRFD184724Z | RESISTOR:CARBON MELF CHIP 4.7K 1/8W J TAPING | 1 | \$ 0.05 |
| R483 | | | 1 | \$ 0.05 |
| R484 | | | 1 | \$ 0.05 |
| R485 | | | 1 | \$ 0.05 |
| R486 | | | 1 | \$ 0.05 |
| R487 | | | 1 | \$ 0.05 |
| R488 | BRFD181034Z | RESISTOR:CARBON MELF CHIP 10K 1/8W J TAPING | 1 | \$ 0.05 |
| R489 | BRFD181034Z | RESISTOR:CARBON MELF CHIP 10K 1/8W J TAPING | 1 | \$ 0.05 |

| (SYMBOL) | (PARTS CODE) | (DESCRIPTION) | (QTY) | (LIST PRICE) |
|----------|--------------|--|-------|--------------|
| R491 | BRFD181034Z | RESISTOR:CARBON MELF CHIP 10K 1/8W J TAPING | 1 | \$ 0.05 |
| R492 | | | 1 | \$ 0.05 |
| R493 | BRFD181524Z | RESISTOR:CARBON MELF CHIP 2.2K 1/8W J TAPING | 1 | \$ 0.05 |
| R494 | BRFD181034Z | RESISTOR:CARBON MELF CHIP 10K 1/8W J TAPING | 1 | \$ 0.05 |
| R496 | | | 1 | \$ 0.05 |
| R501 | BRUB612244Z | RESISTOR:CARBON FORMED VERT 220K 1/6W J | 1 | \$ 0.04 |
| R502 | BRUB611034Z | RESISTOR:CARBON FORMED VERT 10K 1/6W J | 1 | \$ 0.04 |
| R504 | | | 1 | \$ 0.04 |
| R505 | | | 1 | \$ 0.04 |
| R506 | BRUB612734Z | RESISTOR:CARBON FORMED VERT 27K 1/6W J | 1 | \$ 0.04 |
| R507 | BRUB615604Z | RESISTOR:CARBON FORMED VERT 56 1/6W J | 1 | \$ 0.04 |
| R508 | BRUB614734Z | RESISTOR:CARBON FORMED VERT 47K 1/6W J | 1 | \$ 0.04 |
| R509 | BRUB611034Z | RESISTOR:CARBON FORMED VERT 10K 1/6W J | 1 | \$ 0.04 |
| R551 | BRPA612214Z | RESISTOR:CARBON AX TS 26 220 1/6W J TAPING | 1 | \$ 0.04 |
| R552 | BRPA611514Z | RESISTOR:CARBON AX TS 26 150 1/6W J TAPING | 1 | \$ 0.04 |
| R601 | BRPA614704Z | RESISTOR:CARBON AX TS 26 47 1/6W J TAPING | 1 | \$ 0.04 |
| R602 | BRPA611514Z | RESISTOR:CARBON AX TS 26 150 1/6W J TAPING | 1 | \$ 0.04 |
| R603 | BRPA614704Z | RESISTOR:CARBON AX TS 26 47 1/6W J TAPING | 1 | \$ 0.04 |
| R801 | BRPA612224Z | RESISTOR:CARBON AX TS 26 2.2K 1/6W J TAPING | 1 | \$ 0.04 |
| R802 | BRPA611024Z | RESISTOR:CARBON AX TS 26 1K 1/6W J TAPING | 1 | \$ 0.04 |
| R803 | | | 1 | \$ 0.04 |
| R804 | BRPA615624Z | RESISTOR:CARBON AX TS 26 5.6K 1/6W J TAPING | 1 | \$ 0.04 |
| R805 | BRPA614724Z | RESISTOR:CARBON AX TS 26 4.7K 1/6W J TAPING | 1 | \$ 0.04 |
| S301 | BSWY0650001 | SWITCH SW-650 | 1 | \$ 4.21 |
| S601 | BSWY0549001 | SWITCH:PUSH SW-549 PXG22-01 | 1 | \$ 2.37 |
| S602 | | | 1 | \$ 2.37 |
| S603 | BSWY0629001 | SWITCH:PUSH SW-629 | 1 | \$ 2.26 |
| S604 | | | 1 | \$ 2.26 |
| S605 | | | 1 | \$ 2.26 |
| S606 | | | 1 | \$ 2.26 |
| S607 | BSWY0549001 | SWITCH:PUSH SW-549 PXG22-01 | 1 | \$ 2.37 |
| S608 | | | 1 | \$ 2.37 |
| S609 | | | 1 | \$ 2.37 |
| S611 | BSWY0560001 | SWITCH:TACT SW-560 SKHJAB | 1 | \$ 1.29 |
| S612 | | | 1 | \$ 1.29 |
| S801 | BSWY0549001 | SWITCH:PUSH SW-549 PXG22-01 | 1 | \$ 2.37 |
| S802 | | | 1 | \$ 2.37 |
| S901 | BSRY0404001 | SWITCH:ROTARY SR-404 USW-0460 | 1 | \$ 9.61 |
| S911 | BSRY0405001 | SWITCH:ROTARY SR-405 USW-0461 | 1 | \$ 10.18 |
| T001 | BTFY0380001 | TRANS:AF CHOKE TF-380 | 1 | \$ 2.18 |
| | CUHH003041Z | WIRE UL 1007 #26 10- 30- 3 GRY | 1 | \$ 0.04 |
| | CUHG008044Z | WIRE UL 1007 #26 10- 80-10 VIO | 1 | \$ 0.07 |
| | CUHA012044Z | WIRE UL 1007 #26 10-120-10 BRN | 1 | \$ 0.07 |
| | CUHH010044Z | WIRE UL 1007 #26 10-100-10 GRY | 1 | \$ 0.07 |

| (SYMBOL) | (PARTS CODE) | (DESCRIPTION) | (QTY) | (LIST PRICE) |
|----------|--------------|---------------------------------------|-------|--------------|
| | CUHF010044Z | WIRE UL 1007 #26 10-100-10 BLU | 1 | \$ 0.07 |
| | CUHD010044Z | WIRE UL 1007 #26 10-100-10 YEL | 1 | \$ 0.07 |
| | CUHG008044Z | WIRE UL 1007 #26 10- 80-10 VIO | 1 | \$ 0.07 |
| | CUHJ010044Z | WIRE UL 1007 #26 10-100-10 WHI | 1 | \$ 0.07 |
| | CUHB012044Z | WIRE UL 1007 #26 10-120-10 RED | 1 | \$ 0.07 |
| | CUHC012044Z | WIRE UL 1007 #26 10-120-10 ORG | 1 | \$ 0.07 |
| | CUHA017044Z | WIRE UL 1007 #26 10-170-10 BRN | 1 | \$ 0.09 |
| | CUHF019044Z | WIRE UL 1007 #26 10-190-10 BLU | 1 | \$ 0.09 |
| | CUHV018044Z | WIRE UL 1007 #26 10-180-10 PNK | 1 | \$ 0.09 |
| | CUHF006021Z | WIRE UL 1007 #26 5- 60- 3 BLU | 1 | \$ 0.03 |
| | CUHB006021Z | WIRE UL 1007 #26 5- 60- 3 RED | 1 | \$ 0.03 |
| | CUHD006021Z | WIRE UL 1007 #26 5- 60- 3 YEL | 1 | \$ 0.03 |
| X001 | BQXY0122002 | CRYSTAL QX-122 10.6975 | 1 | \$ 0.50 |
| X301 | BQXY0122001 | CRYSTAL QX-122 10.2417 | 1 | \$ 0.50 |
| X302 | BQXY0287001 | CRYSTAL QX-287 22.0MHZ | 1 | \$ 9.24 |
| X303 | BQXY0126001 | CRYSTAL QX-126 3.579545MHZ | 1 | \$ 3.42 |
| Y301 | BYYY0548001 | CERAMIC RESONATOR YY-548 CSA2.000MK | 1 | \$ 4.86 |
| FT001 | BFLY0271001 | FILTER FL-271 219SB-302 | 1 | \$ 6.94 |
| FT002 | BFLY0090001 | FILTER:CRYSTAL FL-090 UMF-058(10.695) | 1 | \$ 0.50 |
| FT004 | BFLY0272001 | FILTER FL-272 219SB-303 | 1 | \$ 6.94 |
| FT401 | BFLY0346001 | FILTER FL-346 | 1 | \$ 9.64 |
| FT402 | BFLY0074001 | FILTER:CERAMIC FL-074 CFW455E | 1 | \$ 5.99 |
| IC001 | BDEY0582001 | INTEGRATED CIRCUIT M5223L | 1 | \$ 1.62 |
| IC002 | BDEY0603001 | INTEGRATED CIRCUIT TDA1905 | 1 | \$ 3.37 |
| IC003 | BDEY0130001 | INTEGRATED CIRCUIT AN612 | 1 | \$ 7.28 |
| IC004 | BDEY0218001 | INTEGRATED CIRCUIT NJM4558S | 1 | \$ 1.33 |
| IC005 | BDEY0364001 | INTEGRATED CIRCUIT TA7320P | 1 | \$ 3.69 |
| IC006 | BDEY0924001 | INTEGRATED CIRCUIT L7808CV | 1 | \$ 1.64 |
| IC301 | BDEY1084001 | INTEGRATED CIRCUIT PLL0305A | 1 | \$ 9.68 |
| IC302 | BDEY1020001 | INTEGRATED CIRCUIT SM5152A1 | 1 | \$ 16.84 |
| IC303 | BDEY1108001 | INTEGRATED CIRCUIT M54460L | 1 | \$ 11.34 |
| IC304 | BDEY0132001 | INTEGRATED CIRCUIT S042P | 1 | \$ 3.07 |
| IC305 | | | 1 | \$ 3.07 |
| IC306 | BDEY1110001 | INTEGRATED CIRCUIT NJM3404AS | 1 | \$ 5.27 |
| IC307 | BDEY0218001 | INTEGRATED CIRCUIT NJM4558S | 1 | \$ 1.33 |
| IC311 | BDEY0996001 | INTEGRATED CIRCUIT L78M08CV | 1 | \$ 1.53 |
| IC312 | BDEY0995001 | INTEGRATED CIRCUIT L78M05CV | 1 | \$ 1.53 |
| IC313 | BDEY1510001 | INTEGRATED CIRCUIT S7116A | 1 | \$ 27.53 |
| IC314 | BDEY1098001 | INTEGRATED CIRCUIT M51953BL | 1 | \$ 2.92 |
| IC315 | BDEY1509001 | INTEGRATED CIRCUIT UC1251 | 1 | \$ 28.91 |
| IC316 | BDEY1155001 | INTEGRATED CIRCUIT HD14093BP | 1 | \$ 2.11 |
| IC401 | BDEY0389001 | INTEGRATED CIRCUIT IR3N06 | 1 | \$ 3.40 |
| IC501 | BDEY1136001 | INTEGRATED CIRCUIT IR2429 | 1 | \$ 20.05 |
| IC502 | BDEY1021001 | INTEGRATED CIRCUIT LH5008TP | 1 | \$ 17.00 |

| (SYMBOL) | (PARTS CODE) | (DESCRIPTION) | (QTY) | (LIST PRICE) |
|----------|--------------|---|-------|--------------|
| LC501 | BDLY0027001 | LIQUID CRYSTAL DISPLAY DL-027 LR634C-A | 1 | \$ 24.72 |
| MC511 | BMKY0388001 | MICROPHONE MK-388 | 1 | \$ 37.33 |
| PL501 | BPLY0105001 | PILOT LAMP PL-105 | 1 | \$ 2.39 |
| RR301 | BHAY0117001 | R:ARRAY HA-117 | 1 | \$ 2.67 |
| RR302 | BHAY0096001 | R:ARRAY HA-096 47K*9 | 1 | \$ 2.89 |
| RR303 | BHAY0093001 | R:ARRAY HA-093 | 1 | \$ 1.73 |
| SP551 | BSPY0181001 | SPEAKER SP-181 | 1 | \$ 6.24 |
| TP002 | BTPY0044001 | TERMINAL:CHECK POINT TP-044 | 1 | \$ 0.21 |
| TP003 | | | 1 | \$ 0.21 |
| TP004 | | | 1 | \$ 0.21 |
| VR001 | BRTY0528223 | RESISTOR:SEMI-FIXED RT-528 22KB | 1 | \$ 0.75 |
| VR002 | BRTY0528104 | RESISTOR:SEMI-FIXED RT-528 100KB | 1 | \$ 0.75 |
| VR003 | BRTY0528473 | RESISTOR:SEMI-FIXED RT-528 47KB | 1 | \$ 0.75 |
| VR004 | BRTY0528103 | RESISTOR:SEMI-FIXED RT-528 10KB | 1 | \$ 0.75 |
| VR005 | | | 1 | \$ 0.75 |
| VR006 | BRTY0528102 | RESISTOR:SEMI-FIXED RT-528 1KB | 1 | \$ 0.75 |
| VR007 | BRTY0528103 | RESISTOR:SEMI-FIXED RT-528 10KB | 1 | \$ 0.75 |
| VR008 | BRTY0528223 | RESISTOR:SEMI-FIXED RT-528 22KB | 1 | \$ 0.75 |
| VR009 | BRTY0528103 | RESISTOR:SEMI-FIXED RT-528 10KB | 1 | \$ 0.75 |
| VR010 | | | 1 | \$ 0.75 |
| VR011 | | | 1 | \$ 0.75 |
| VR012 | BRTY0528473 | RESISTOR:SEMI-FIXED RT-528 47KB | 1 | \$ 0.75 |
| VR013 | BRTY0182101 | RESISTOR:SEMI-FIXED RT-182 TT24R 100B | 1 | \$ 0.34 |
| VR014 | BRTY0182102 | RESISTOR:SEMI-FIXED RT-182 TT24R 1KB | 1 | \$ 0.34 |
| VR301 | BRTY0528101 | RESISTOR:SEMI-FIXED RT-528 100B | 1 | \$ 0.75 |
| VR302 | | | 1 | \$ 0.75 |
| VR303 | BRTY0528223 | RESISTOR:SEMI-FIXED RT-528 22KB | 1 | \$ 0.75 |
| VR304 | BRTY0528103 | RESISTOR:SEMI-FIXED RT-528 10KB | 1 | \$ 0.75 |
| VR601 | BRVY0672001 | RESISTOR:VARIABLE RV-672 5KB | 1 | \$ 3.00 |
| VR701 | BRVY0677001 | RESISTOR:VARIABLE RV-677 RK0971111 50KA W/S | 1 | \$ 5.27 |
| VR702 | BRVY0678001 | RESISTOR:VARIABLE RV-678 RK0971111 50KB W/S | 1 | \$ 5.27 |
| VR801 | BRVY0652001 | RESISTOR:VARIABLE RV-652 VB12L PVB20F B1K | 1 | \$ 2.59 |
| VR802 | BRVY0679001 | RESISTOR:VARIABLE RV-679 10KB | 1 | \$ 2.78 |
| | CZDZ071399Z | WIRES ASSEMBLED W-071399 | 1 | \$ 3.36 |
| | CZDZ071398Z | WIRES ASSEMBLED W-071398 | 1 | \$ 2.59 |
| | CZDZ071507Z | WIRES:ASSEMBLED W-071507 | 1 | \$ 4.08 |
| | CZDZ071506Z | WIRES:ASSEMBLED W-071506 | 1 | \$ 3.89 |
| | CZDZ071395Z | WIRES ASSEMBLED W-071395 | 1 | \$ 2.48 |
| | CZDZ071505A | WIRES:ASSEMBLED W-071505A | 1 | \$ 6.87 |
| | CZDZ071393A | WIRES ASSEMBLED W-071393A | 1 | \$ 1.26 |
| | CZDZ071392Z | WIRES ASSEMBLED W-071392 | 1 | \$ 1.38 |
| | CZDZ071391Z | WIRES ASSEMBLED W-071391 | 1 | \$ 6.04 |
| | CZDZ071400B | WIRES ASSEMBLED W-071400B | 1 | \$ 8.36 |
| | CZDZ071511Z | WIRES:ASSEMBLED W-071511 | 1 | \$ 1.03 |

| (SYMBOL) | (PARTS CODE) | (DESCRIPTION) | (QTY) | (LIST PRICE) |
|----------|--------------|-----------------------|------------------------------|--------------|
| | CZDZ071389Z | WIRES ASSEMBLED | W-071389 | 1 \$ 1.08 |
| | CZDZ071512Z | WIRES:ASSEMBLED | W-071512 | 1 \$ 2.25 |
| | CZDZ071387A | WIRES ASSEMBLED | W-071387A | 1 \$ 1.01 |
| WA015 | BWZY0692001 | CORD | WZ-692 230 W/P | 1 \$ 4.05 |
| WA016 | BWZY0693001 | CORD | WZ-693 270 W/P | 1 \$ 4.19 |
| | CZDZ071402A | WIRES ASSEMBLED | W-071402A | 1 \$ 1.46 |
| WA018 | BWZY0727001 | CORD | WZ-727 | 1 \$ 1.52 |
| | CZDZ071503Z | WIRES:ASSEMBLED | W-071503 | 1 \$ 1.00 |
| WA020 | BWZY0721001 | DC CORD | WZ-721 1830 W/P | 1 \$ 9.48 |
| | CZDZ071401Z | WIRES ASSEMBLED | W-071401 | 1 \$ 2.81 |
| YI501 | BYDY0010003 | INSULATION SHEET | YD-010 P101KD | 1 \$ 0.02 |
| YI502 | BYYY0172001 | BUSHING:TIGHT CERAMIC | YY-172 | 1 \$ 0.28 |
| YI503 | | | | 1 \$ 0.28 |
| YW501 | BYYY0047001 | WIRE CLAMPER | YY-047 | 1 \$ 0.05 |
| YW502 | | | | 1 \$ 0.05 |
| YW503 | | | | 1 \$ 0.05 |
| YW504 | | | | 1 \$ 0.05 |
| YW505 | | | | 1 \$ 0.05 |
| YW506 | | | | 1 \$ 0.05 |
| YW507 | | | | 1 \$ 0.05 |
| YW508 | | | | 1 \$ 0.05 |
| YW509 | | | | 1 \$ 0.05 |
| YW510 | | | | 1 \$ 0.05 |
| | FCSR221155Z | CHASSIS:REAR | ADC-12. PAINT BLACK | 1 \$ 23.31 |
| | GCMF192098Z | PANEL:FRONT | ABS. DARK GRAY PAINT SILK | 1 \$ 7.52 |
| | GCMZ492099Z | PLATE:DISPLAY | PMMA, SILK | 1 \$ 2.61 |
| | GHDZ320936Z | HOLDER:LCD | ABS, WHITE | 1 \$ 1.35 |
| | GMSC480407Z | SCREW:MOUNTING | ABS, BLACK | 4 \$ 0.54 |
| | GNBC421145Z | KNOB:CHANNEL | ABS, DARK GRAY | 1 \$ 1.10 |
| | GNBP420940Z | BUTTON:CHANNEL | ABS, SATIN CR | 2 \$ 1.40 |
| | GNBP421146Z | Kn:JB:PUSH | ABS, DARK GRAY | 5 \$ 0.33 |
| | GNBP421147Z | KNOB:PUSH | ABS, NEUTRAL GRAY | 6 \$ 0.33 |
| | GNBY420939Z | KNOB | ABS, DARK GRAY | 6 \$ 0.55 |
| | HBCT380105A | MOUNTING BRACKET | SPCC 1.6T PAINT DARK GRAY | 1 \$ 7.26 |
| | HCMB221190A | CASE:BOTTOM | VINYTOP, SB-K08, 1.0T, BLACK | 1 \$ 9.19 |
| | HCMT221191Z | CASE:TOP | VINYTOP, SB-K08, 1.0T, BLACK | 1 \$ 8.65 |
| | HCSS321192B | CHASSIS:SIDE | SECC, 1.0T, NON OIL | 2 \$ 2.59 |
| | HHSK418834D | HEAT SINK | C5191R, 0.5T | 1 \$ 0.71 |
| | HMHG402919Z | HANGER:MICROPHONE | SPCC, 1.0T, NI | 1 \$ 0.44 |
| | HSDC321193B | SHIELD CASE | SECC, 0.8T | 1 \$ 4.14 |
| | HSDP420091Z | SHIELD PLATE | SPTE, 0.3T | 1 \$ 0.23 |
| | HSDP421141Z | FRAME:LCD | SPTE, 0.3T, NON OIL | 1 \$ 0.67 |
| | HSDP421142Z | SHIELD PLATE | SPTE, 0.3T, NON OIL | 1 \$ 0.51 |
| | HSDP421143Z | PLATE:ESD (R) | SPTE, 0.3T, NON OIL | 1 \$ 0.75 |

| (SYMBOL) | (PARTS CODE) | (DESCRIPTION) | (QTY) | (LIST PRICE) |
|-------------|-----------------------------|--------------------------|----------|--------------|
| HSDP421144Z | PLATE:ESD (L) | SPTE. 0. 3T, NON OIL | 1 | \$ 0. 60 |
| HSDP491778Z | SHIELD PLATE | SPTE 0. 3T NON OIL | 1 | \$ 0. 49 |
| HSDP492100Z | SHIELD PLATE | SPTE. 0. 3T NON OIL | 1 | \$ 0. 30 |
| PLBC482147Z | LABEL:WARNING, DC CORD | PAPER, PRINT | 1 | \$ 0. 15 |
| PLBF492101Z | LABEL:REAR | POLYESTER FILM 0. 1T | 1 | \$ 0. 38 |
| PLBZ422139Z | LABEL:INDICATION | POLYESTER FILM 0. 05T | 1 | \$ 0. 17 |
| RETC421189Z | PLATE:LCD | YUPO PAPER, 0. 15T | 1 | \$ 0. 19 |
| RUTC403865Z | WOOL-COATED PAPER:WOOL TACK | WOOL PAPER, 10*150*0. 3T | 2 | \$ 0. 08 |
| RZEB420092Z | INSULATION PLATE | PC, 0. 2T | 1 | \$ 0. 17 |
| RZEB491779Z | INSULATION PLATE | PVC 0. 35T | 1 | \$ 0. 88 |
| RZEB492102Z | INSULATION PLATE | PVC 0. 3T | 1 | \$ 0. 19 |
| TSTD0150007 | TERMINAL:LUG SOLDER | D3. 2X14 | 2 | \$ 0. 07 |
| TSTD0200003 | SPRING PLATE:KNOB | D6. 02XL9. 53 | 7 | \$ 0. 17 |
| UTUD01550CZ | OWNER'S MANUAL | ** | 1 | \$ 0. 50 |
| UTUD492088Z | LABEL:NOTICE | PAPER PRINT | 1 | \$ 1. 13 |
| | | | 1 | \$ 1. 13 |
| VNYL1114000 | VINYL BAG | 110X400X0. 05T | 1 | \$ 0. 08 |
| VNYL1122800 | VINYL BAG | 120X280X0. 05T | 1 | \$ 0. 05 |
| VNYL1173200 | VINYL BAG | 170X320X0. 05T | 1 | \$ 0. 09 |
| VNYL2465270 | VINYL BAG | 460X520X700X0. 07T | 0. 16666 | \$ 1. 88 |
| VNYL3101200 | VINYL BAG | 100X120X0. 1T | 1 | \$ 0. 06 |
| VNYL3324500 | VINYL BAG | 320X450X0. 1T | 1 | \$ 0. 50 |
| WBXC392103Z | DISPLAY BOX | ** | 1 | \$ 0. 50 |
| WCTZ392104Z | SHIPPING CARTON BOX | ** | 0. 16666 | \$ 0. 50 |
| WSFC121185Z | STYROFOAM PAD (R) | ** | 1 | \$ 2. 40 |
| WSFC221184A | STYROFOAM PAD(F) | ** | 1 | \$ 1. 58 |
| WSLV421401Z | SPACER | ** | 1 | \$ 0. 26 |
| SMHR2600 | SERVICE MANUAL | | | |

5. IC VOLTAGE CHART

| | IC 1 | IC 2 | IC 3 | IC 4 | IC 5 | IC 6 | IC 301 | IC 302 |
|---------|--------------|---|--|--|--|---------|----------------------|------------|
| Pin No. | M5223L | 7DA1905 | AN612 | NJM4558S | TA7320P | L7808CV | PLLO305A | MS152A1 |
| 1 | 0 | 7.0 11.0 | 2.4 | 7.5 | 0 6.2 | 13.6 | 4.8 | 2.0 |
| 2 | 0 | 13.6 | 3.2 | 4.1 | 0 3.7 | 0 | 0 | 2.4 |
| 3 | 0 | 12.1 | 3.2 | 4.1 | 0 3.0 | 8.0 | 4.8 | 4.8 |
| 4 | 0 | — | 0 | 4.1 | 0 7.5 | | 4.9 | 3.9 |
| 5 | 1.0 (9.0) | — | 5.9 | 0 | 0 0 | | 4.8 | 0 |
| 6 | 1.7 (1.7) | 2.6 4.0 | 7.4 | 3.7 | 0 2.5 | | 0 4.7 | 2.1 4.2 |
| 7 | 0 (6.8) | 2.6 4.4 | 6.3 4.0 | 7.5 2.0 | 0 4.0 | | 0 | 0 4.2 |
| 8 | 8.0 | 2.5 9.5 | | 1.3 6.0 | 0 7.0 | | 4.8 | 0 4.2 |
| 9 | | | | 7.5 | 0 7.5 | | 2.2 6.200MHZ | 0 4.2 |
| 10 | | | | | | | 0 4.8 | |
| 11 | | | | | | | 0 4.8 | |
| 12 | | | | | | | 0 4.8 | |
| 13 | | | | | | | 100 3.9 0 | |
| 14 | | | | | | | 10.240 — | |
| 15 | | | | | | | 10.240 3.8 | |
| 16 | | | | | | | 10.240 2.1 2.0 | |
| 17 | | | | | | | 10.240 2.2 | |
| 18 | | | | | | | 10.240 0 | |
| 19 | | | | | | | | |
| 20 | | | | | | | | |
| 21 | | | | | | | | |
| 22 | | | | | | | | |

- DC VOLTAGE IN SHOWS TX CONDITION.
- DC VOLTAGE IN NO MARK SHOWS RX CONDITION.
- DC VOLTAGE IN () SHOWS RX CONDITION OPERATION OF EACH FUNCTION.

| | IC303 | IC304 | IC305 | IC306 | IC307 | IC311 | IC312 | IC313 |
|---------|---------|-------|-------|-----------|----------|-----------|-----------|---------|
| Pin No. | M51460L | S042P | S042P | M1M3408AS | M1M3558S | L781408CV | L781405CV | S-7116A |
| 1 | 0 | 0 | 0 | 7.7 | - | 13.6 | 13.6 | 3.5 |
| 2 | - | 4.6 | 4.9 | 5.7 | - | 0 | 0.6 | 0 |
| 3 | 0 | 7.7 | 7.7 | 3.9 | - | 7.7 | 5.6 | 0 |
| 4 | 1.1 | 0 | 0 | 3.9 | - | | | - |
| 5 | 1.5 | 7.7 | 7.7 | 0 | 0 | | | 2.6 |
| 6 | 4.8 | 0 | 0 | | 4.1 | | | 4.8 |
| 7 | - | 2.7 | 2.7 | | 4.1 | | | 0 |
| 8 | 0.5 | 2.7 | 2.7 | | 3.1 | | | - |
| 9 | | 0 | 0 | | 7.7 | | | - |
| 10 | | 0.5 | 0.5 | | | | | - |
| 11 | | 1.2 | 1.3 | | | | | (4.8) |
| 12 | | 0.5 | 0.5 | | | | | - |
| 13 | | 1.2 | 1.3 | | | | | - |
| 14 | | 0 | 0 | | | | | 4.8 |
| 15 | | | | | | | | |
| 16 | | | | | | | | |
| 17 | | | | | | | | |
| 18 | | | | | | | | |
| 19 | | | | | | | | |
| 20 | | | | | | | | |
| 21 | | | | | | | | |
| 22 | | | | | | | | |

- DC VOLTAGE IN SHOWS TX CONDITION.
- DC VOLTAGE IN SHOWS RX CONDITION.
- DC VOLTAGE IN () SHOWS PX CONDITION OPERATION OF EACH FUNCTION.

| | IC314 | IC315 | IC315 | IC315 | IC316 | IC401 | IC501 | IC502 |
|--------|----------|---------|--------|--------|------------|--------|--------|----------------|
| Pin No | M51753B1 | UC-1251 | Pin No | Pin No | 11D14073BP | IR3N06 | IR2429 | Pin No LH018TP |
| 1 | 4.8 | 5 0 | 23 0 | 25 5 | 4.9 | (8) | * | 1 |
| 2 | - | 0 0 | 24 0 | 26 5 | 0 | - | * | 2 |
| 3 | 0 | 5 0 | 25 5 | 27 4.4 | 4.9 | (7.7) | * | 3 3.4 |
| 4 | 1.1 | 0 0 | 26 5 | 28 4.4 | 0 | (8.0) | * | 4 2.6 |
| 5 | 4.8 | 5 0 | 27 5 | 29 4.4 | 4.9 | (1.0) | * | 5 1.8 |
| 6 | | 0 0 | 28 0 | 30 4.4 | 4.9 | (1.0) | * | 6 5.0 |
| 7 | | 5 0 | 29 0 | 31 4.4 | 2.5 | 0 | * | 7 0 |
| 8 | | 5 0 | 30 0 | 32 4.4 | 2.5 | - | * | 8 5 |
| 9 | | 5 0 | 31 0 | 33 4.4 | 0 | - | * | 9 0 |
| 10 | | 5 0 | 32 5 | 34 4.5 | 0 | - | * | 10 5 |
| 11 | | 5 0 | 33 5 | 35 5 | 4.9 | | * | 11 0 |
| 12 | | 5 0 | 34 5 | 36 5 | 0 | | * | 12 0 |
| 13 | | 5 4.4 | 35 0 | 37 1 | 4.9 | | * | 13 5 |
| 14 | | 0 0 | 36 5 | 38 5 | 4.9 | | - | 14 0 |
| 15 | | 0 0 | 37 5 | 39 0 | | | 3.3 | 15 |
| 16 | | 0 0 | 38 5 | 60 5 | | | 1.0 | 16 - |
| 17 | | 5 4.4 | 39 5 | 61 0 | | | - | 17 5.0 |
| 18 | | 5 4.4 | 40 0 | 62 4.4 | 0 | | 4.0 | 18 - |
| 19 | | 5 4.4 | 41 0 | 63 4.4 | 0 | | 0.6 | 19 |
| 20 | | 0 0 | 42 0 | 64 4.4 | 5 | | 0 | |
| 21 | | 0 0 | 43 0 | | | | 0 | |
| 22 | | 5 4.4 | 44 0 | | | | 0 | |

- DC VOLTAGE IN SHOWS TX CONDITION.
- DC VOLTAGE IN NO MARK SHOWS RX CONDITION.
- DC VOLTAGE IN () SHOWS RX CONDITION OPERATION OF EACH FUNCTION.

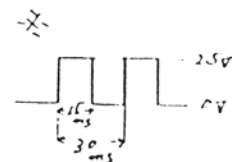

6. FREQUENCY CHART

FREQUENCIES OF LOCAL OSCILLATORS

$$F_v = F + 10.6950 \text{ (MHz)} + \alpha$$

$$\left(\begin{array}{l} F : \text{TRANSMITTING AND RECEIVING FREQUENCY} \\ F_v : \text{VCO OUTPUT FREQUENCY} \\ \alpha \left\{ \begin{array}{ll} 0 & \text{(FM / AM)} \\ + 2.5 \text{ kHz} & \text{(USB)} \\ - 2.5 \text{ kHz} & \text{(LSB)} \\ + 1.7 \text{ kHz} & \text{(CW)} \end{array} \right. \end{array} \right)$$

CHANNEL AND FREQUENCY RANGE

| BAND | FREQUENCY RANGE |
|------|-----------------------|
| A | 28.0000 ~ 28.4999 MHz |
| B | 28.5000 ~ 28.9999 MHz |
| C | 29.0000 ~ 29.4999 MHz |
| D | 29.5000 ~ 29.6999 MHz |

7. EXPLODED VIEW & MECHANICAL PARTS LIST

PARTS LIST FOR EXPLODED VIEW

Model Name : HR-2600

| (No.) | (PARTS CODE) | (DESCRIPTION) | | |
|-------|--------------|-----------------------------|------------------------------|----|
| 1 | FCSR221155Z | CHASSIS:REAR | ADC-12, PAINT BLACK | |
| 2 | GCMF192098Z | PANEL:FRONT | ABS, DARK GRAY PAINT SILK | |
| 3 | GCMZ492099Z | PLATE:DISPLAY | PMMA, SILK | |
| 4 | GHDZ320936Z | HOLDER:LCD | ABS, WHITE | |
| 5 | GNBC421145Z | KNOB:CHANNEL | ABS, DARK GRAY | |
| 6 | GNBP420940Z | BUTTON:CHANNEL | ABS, SATIN CR | x2 |
| 7 | GNBP421146Z | KNOB:PUSH | ABS, DARK GRAY | x5 |
| 8 | GNBP421147Z | KNOB:PUSH | ABS, NEUTRAL GRAY | x6 |
| 9 | GNBY420939Z | KNOB | ABS, DARK GRAY | x6 |
| 10 | HCMB221190A | CASE:BOTTOM | VINYTOP, SB-K08, 1.0T, BLACK | |
| 11 | HCMT221191Z | CASE:TOP | VINYTOP, SB-K08, 1.0T, BLACK | |
| 12 | HCSS321192B | CHASSIS:SIDE | SECC, 1.0T, NON OIL | x2 |
| 13 | HHSK418834D | HEAT SINK | C5191R, 0.5T | |
| 14 | HSDC321193B | SHIELD CASE | SECC, 0.8T | |
| 15 | HSDP420091Z | SHIELD PLATE | SPTE, 0.3T | |
| 16 | HSDP421141Z | FRAME:LCD | SPTE, 0.3T, NON OIL | |
| 17 | HSDP421142Z | SHIELD PLATE | SPTE, 0.3T, NON OIL | |
| 18 | HSDP421143Z | PLATE:ESD (R) | SPTE, 0.3T, NON OIL | |
| 19 | HSDP421144Z | PLATE:ESD (L) | SPTE, 0.3T, NON OIL | |
| 20 | -Not Used- | | | |
| 21 | HSDP492100Z | SHIELD PLATE | SPTE, 0.3T NON OIL | |
| 22 | PLBC482147Z | LABEL:WARNING, DC CORD | PAPER, PRINT | |
| 23 | PLBF492101Z | LABEL:REAR | POLYESTER FILM 0.1T | |
| 24 | PLBZ422139Z | LABEL:INDICATION | POLYESTER FILM 0.05T | |
| 25 | RETC421189Z | PLATE:LCD | YUPO PAPER, 0.15T | |
| 26 | RUTC403865Z | WOOL-COATED PAPER:WOOL TACK | WOOL PAPER, 10*150*0.3T | x2 |
| 27 | RZEB420092Z | INSULATION PLATE | PC, 0.2T | |
| 28 | -Not Used- | | | |
| 29 | RZEB492102Z | INSULATION PLATE | PVC 0.3T | |
| 30 | TSTD0150007 | TERMINAL:LUG SOLDER | D3, 2X14 | x2 |
| 31 | TSTD0200003 | SPRING PLATE:KNOB | D6, 02XL9, 53 | x7 |
| 51 | SSCW133005N | SCREW:FLAT HD + | M3X5 NI | x4 |
| 52 | SSCW133005N | SCREW:FLAT HD + | M3X5 NI | x4 |
| 53 | SSCW192012N | SCREW:BIND HD + | M2X12 NI | x2 |
| 54 | SSCW193006N | SCREW:BIND HD + | M3X6 NI | x4 |
| 55 | SSCW193006N | SCREW:BIND HD + | M3X6 NI | x2 |
| 56 | SSCW193006N | SCREW:BIND HD + | M3X6 NI | x4 |
| 57 | SSCW193008B | SCREW:BIND HD + | M3X8 BNI | x4 |
| 58 | SSCW193008N | SCREW:BIND HD + | M3X8 NI | |
| 59 | SSCW343006B | SCREW:TAPTIGHT BIND HD + | M3X6 BNI | x8 |
| 60 | SSCW343006N | SCREW:TAPTIGHT BIND HD + | M3X6 NI | x4 |
| 61 | SSCW430030N | HEX NUT | M3, 0 NI | |
| 62 | SSCW480030Z | NUT:FLANGE | M3 ZMC | x4 |
| 63 | SSCW803008N | SCREW:P TIGHT BIND HD + | D3X8 NI | x3 |
| 64 | SSCW803008N | SCREW:P TIGHT BIND HD + | D3X8 NI | |
| 65 | SSCW803008N | SCREW:P TIGHT BIND HD + | D3X8 NI | x2 |
| 66 | SSCW803008N | SCREW:P TIGHT BIND HD + | D3X8 NI | |
| 101 | GMSC480407Z | SCREW:MOUNTING | ABS, BLACK | x4 |
| 102 | HBCT380105A | MOUNTING BRACKET | SPCC 1.6T PAINT DARK GRAY | |
| 103 | HMHG402919Z | HANGER:MICROPHONE | SPCC, 1.0T, NI | |
| 104 | SSCW293508N | SCREW:TAPPING ROUND HD + | D3, 5X8 NI | x2 |
| 105 | SSCW295010N | SCREW:TAPPING ROUND HD + | D5X10 NI | x4 |
| 106 | SSCW490050N | WASHER FLAT | D5 NI | x4 |
| 107 | SSCW530035N | WASHER:LOCK | D3.5 NI | x2 |
| 108 | SSCW540050N | WASHER:STAR | D5 NI | x4 |

NOTE : No. in this Mechanical Parts List corresponds
with the number in Exploded view.

8. TECHNICAL DRAWINGS

BLOCK DIAGRAM

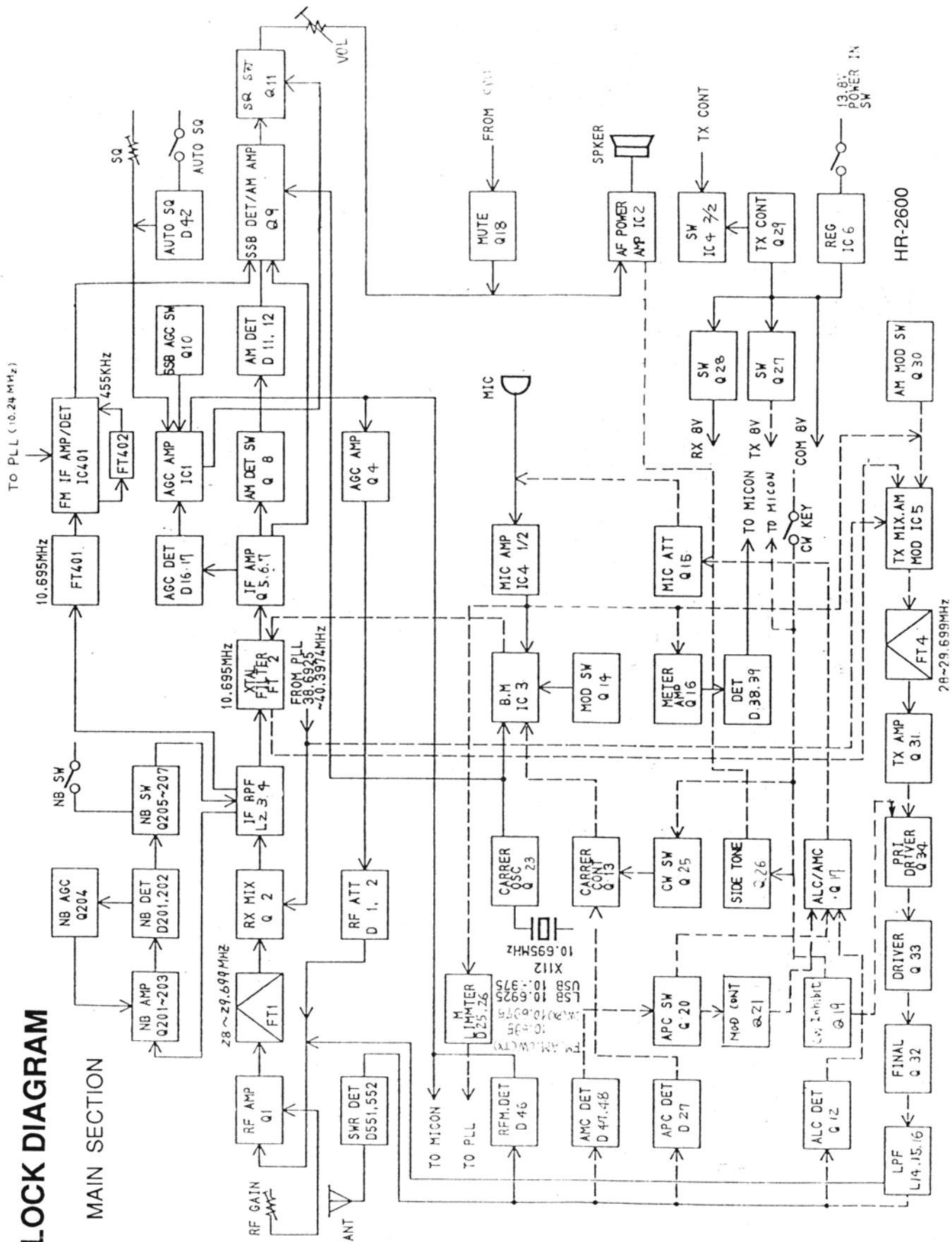

MICOM SECTION

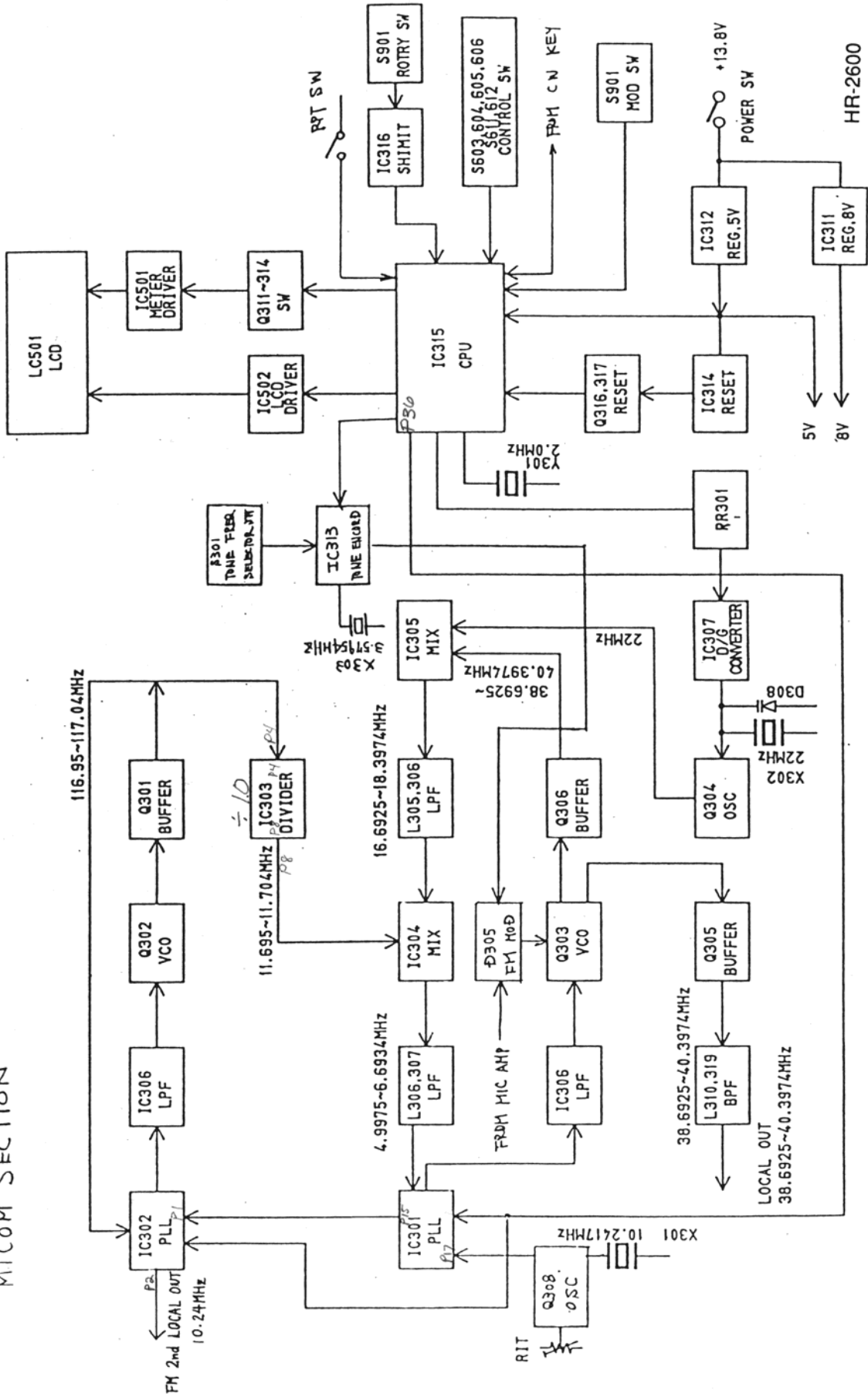

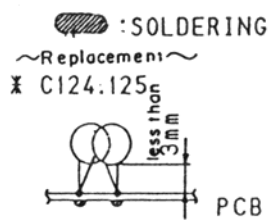
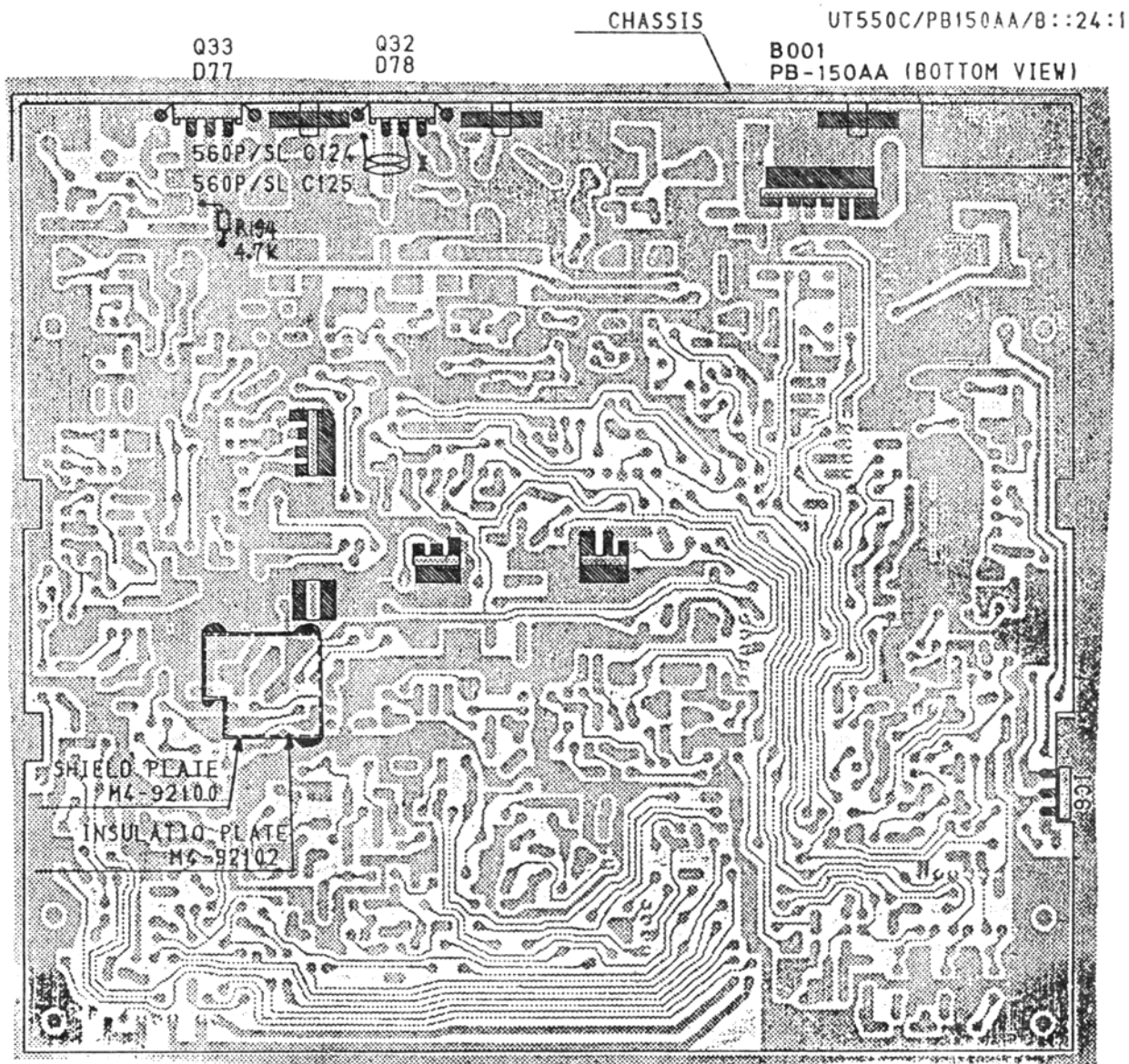

NOTES:
1. CAPACITANCE VALUES ARE INDICATED IN MICRO FARADS UNLESS OTHERWISE NOTED. (P= MICRO-MICRO FRADS)

| | |
|-------------|-----------------------------|
| TITLE | PARTS LAYOUT BOTTOM VIEW |
| DRAWING NO. | E24-8316 |

B201 PB-117AB (TOP VIEW)

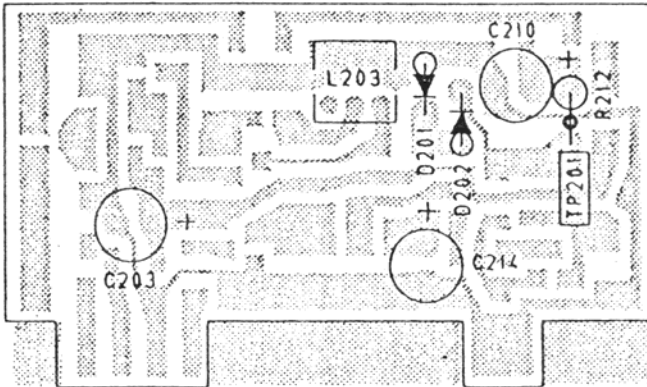

| | |
|------|---------------|
| C203 | 16V10 C-105 |
| C210 | 50V0.47 C-105 |
| C214 | 16V10 C-105 |
| | |
| | |
| | |

| | |
|------|--------|
| D201 | 1N60AM |
| D202 | 1N60AM |
| | |
| | |
| | |

| | |
|------|------|
| R212 | 100K |
| | |
| | |
| | |
| | |

| | |
|------|-------|
| L203 | LF125 |
| | |
| | |
| | |
| | |

B201 (BOTTOM VIEW)

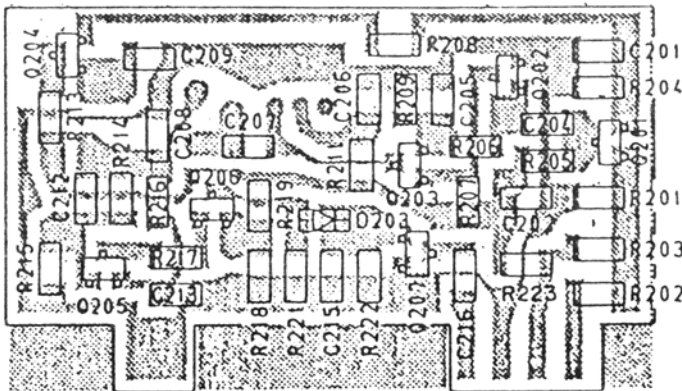

| | |
|------|--------|
| R201 | 10K |
| R202 | 220 |
| R203 | 33K |
| R204 | 680 |
| R205 | 100 |
| R206 | 47K |
| R207 | 1.5K |
| R208 | 330 |
| R209 | 330 |
| R211 | 68 |
| R213 | RZ025 |
| R214 | 10K |
| R215 | 10K |
| R216 | 470K |
| R217 | 10K |
| R218 | 3.3K |
| R219 | 330 |
| R221 | 10K |
| R222 | 3.3K |
| R223 | RZ-025 |
| | |
| | |

| | |
|------|----------|
| C201 | 0.0047/X |
| C202 | 0.047/C |
| C204 | 10P/5L |
| C205 | 0.047/C |
| C206 | 0.0047/X |
| C207 | 0.001/B |
| C208 | 82P/B |
| C209 | 0.01/Y |
| C212 | 330P/B |
| C213 | 0.001/B |
| C215 | 330P/B |
| C216 | 0.01/Y |
| | |
| | |

| | |
|------|-----------|
| Q201 | 25C2814F5 |
| Q202 | 25C2814F5 |
| Q203 | 25C2814F5 |
| Q204 | 25C2812L5 |
| Q205 | 25C2812L5 |
| Q206 | 25A1179M6 |
| Q207 | 25C2814F5 |
| | |
| | |
| | |

| | |
|------|---------|
| D203 | RLS4148 |
| | |
| | |
| | |

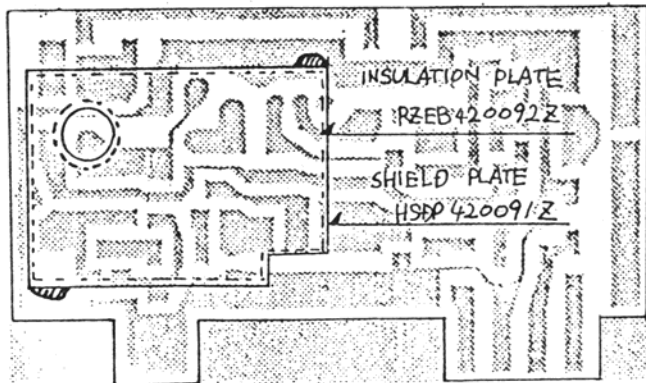

⊙ SOLDERING

NOTES:

1. RESISTANCE VALUES ARE SHOWN IN OHMS UNLESS OTHERWISE NOTED. 1K-XILO OHM. M-MEG OHM!
2. RESISTOR WATTAGES ARE 1/8W UNLESS OTHERWISE NOTED.
3. CAPACITANCE VALUES ARE INDICATED IN MICRO FARADS UNLESS OTHERWISE NOTED. 1P-MICRO-MICRO FARAD!

| | |
|----------|----------------|
| TITLE | NB PCB |
| | PARTS ASSEMBLY |
| E24-8317 | REV. MARK |

(BOTTOM VIEW)

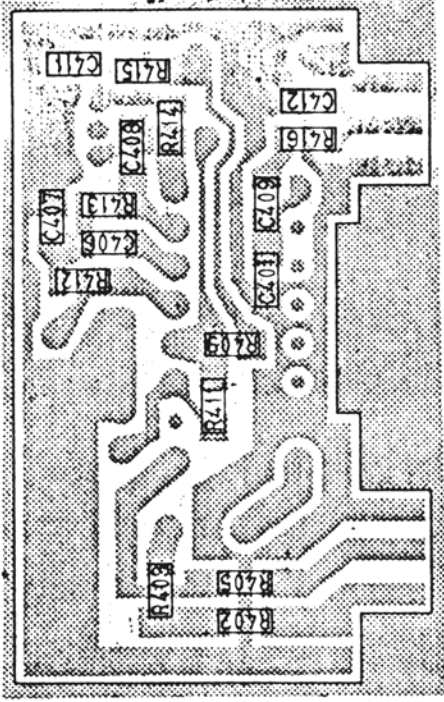

B401
PB-119AC (TOP VIEW)

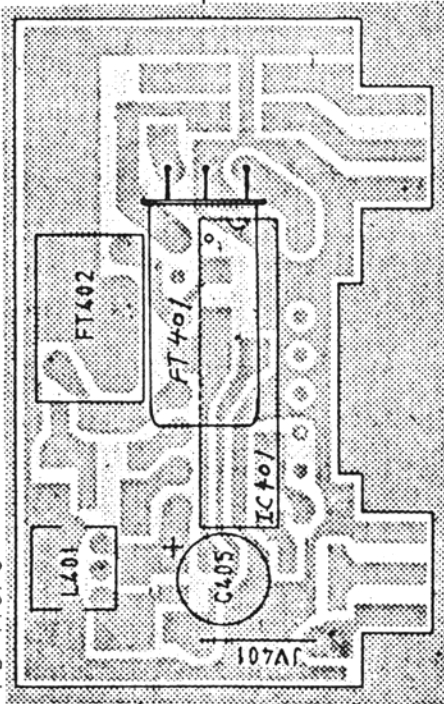

| | |
|------|-------|
| R402 | RZ025 |
| R403 | RZ025 |
| R405 | 1K |
| R409 | 10 |
| R411 | 2.2K |
| R412 | 2.2K |
| R413 | 47K |
| R414 | 68K |
| R415 | 100 |
| R416 | 10K |
| | |
| | |

| | |
|------|---------|
| C401 | 0.022/C |
| C406 | 0.047/C |
| C407 | 0.047/C |
| C408 | 18P/RH |
| C409 | 0.022/C |
| C411 | 0.047/C |
| C412 | 0.022/C |
| | |
| | |
| | |

| | |
|-------|-------|
| FT401 | FL346 |
| FT402 | FL074 |
| | |
| | |

| | |
|-------|--------|
| IC401 | IR3N06 |
| | |
| | |

NOTE

| | |
|-------|-------|
| JV401 | 7.5mm |
| | |
| | |

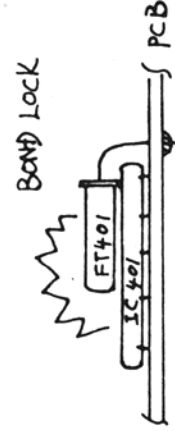

- NOTES:
1. RESISTANCE VALUES ARE SHOWN IN OHMS UNLESS OTHERWISE NOTED, (K=KILO OHM, M=MEG. OHM)
 2. RESISTOR WATTAGES ARE 1/8W UNLESS OTHERWISE NOTED.
 3. CAPACITANCE VALUES ARE INDICATED IN MICRO FARADS UNLESS OTHERWISE NOTED, (P=MICRO-MICRO FARAD)

| |
|-----------------------|
| TITLE |
| FM PCB PARTS ASSEMBLY |
| DRAWING NO. |
| E24-8318 |

B501 PB-112AA (TOP VIEW)

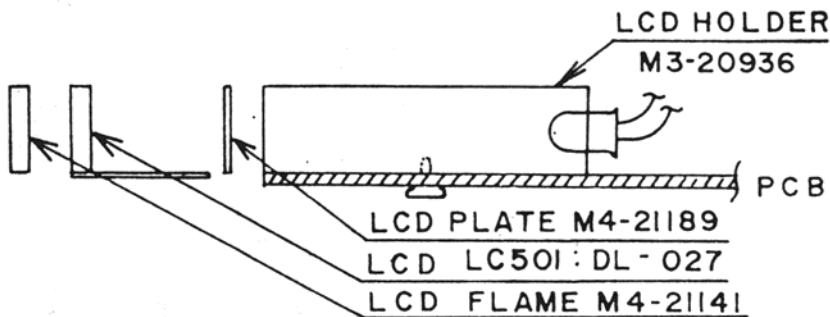
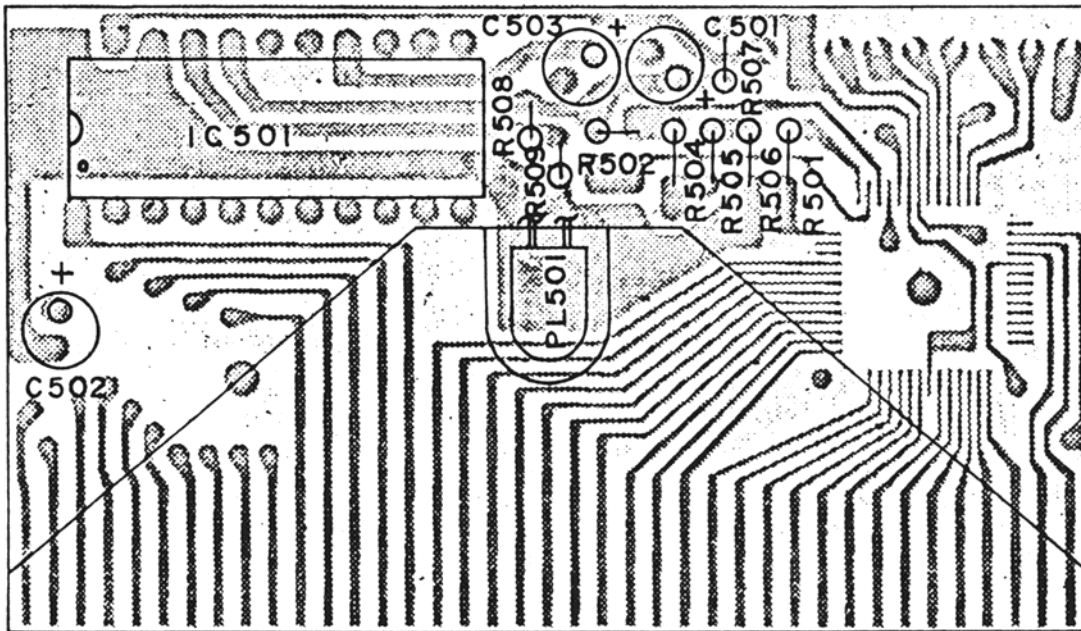

| | |
|--------|--------|
| IC 501 | IR2429 |
| | |
| | |

| | |
|------|------|
| R501 | 220K |
| R502 | 10K |
| R504 | 10K |
| R505 | 10K |
| R506 | 27K |
| R507 | 56 |
| R508 | 47K |
| R509 | 10K |
| | |
| | |

| | |
|-------|--------|
| LC501 | DL-027 |
| | |
| | |

| | |
|------|--------------|
| C501 | 50V 4.7 |
| C502 | 50V 3.3C-105 |
| C503 | 6.3V 100 |
| | |
| | |

| | |
|-------|-------|
| PL501 | PL105 |
| | |
| | |

- NOTES:
1. RESISTANCE VALUES ARE SHOWN IN OHMS UNLESS OTHERWISE NOTED. (K=KILO OHM)
 2. RESISTOR WATTAGES ARE 1/6W UNLESS OTHERWISE NOTED.
 3. CAPACITANCE VALUES ARE INDICATED IN MICRO FARADS UNLESS OTHERWISE NOTED.

| | |
|--------------------|--------|
| TITLE LCD PCB(TOP) | |
| PARTS ASSEMBLY | |
| DRAWING NO. | REV |
| E 24-8319 | 3/8/82 |

B50I PB-112AA (BOTTOM VIEW)

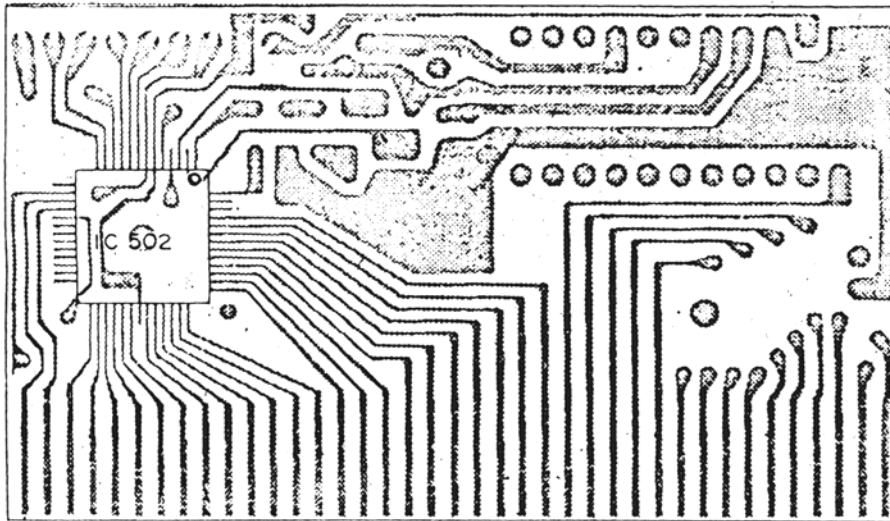

| | |
|-------|----------|
| IC502 | LH5008TP |
| | |

| | |
|------------------------|-----------|
| TITLE LCD PCB (BOTTOM) | |
| PARTS ASSEMBLY | |
| DRAWING NO. | REV. MARK |
| E24-8320 | |

B55I PB118AA (TOP VIEW)

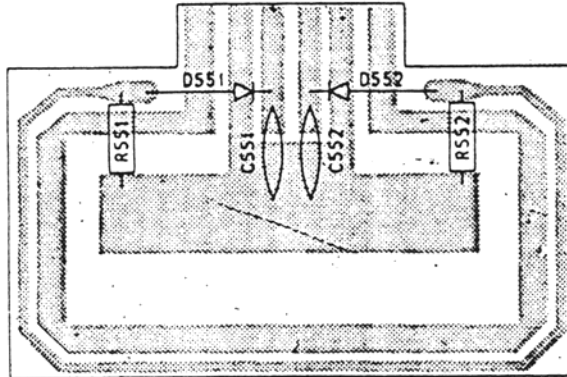

| | |
|------|-----|
| R551 | 220 |
| R552 | 150 |
| | |
| | |
| | |
| | |
| | |

| | |
|------|------|
| C551 | 0.01 |
| C552 | 0.01 |
| | |
| | |
| | |
| | |
| | |

| | |
|------|---------|
| D551 | 1N60 AM |
| D552 | 1N60 AM |
| | |
| | |
| | |
| | |
| | |

- NOTES:
1. RESISTANCE VALUES ARE SHOWN IN OHMS UNLESS OTHERWISE NOTED. (K=KILO OHM, M=MEG OHM)
 2. RESISTOR WATTAGES ARE 1/6W UNLESS OTHERWISE NOTED.
 3. CAPACITANCE VALUES ARE INDICATED IN MICRO FARAD UNLESS OTHERWISE NOTED. (P=MICRO-MICRO FARAD)
 4. ALL CAPACITORS TEMPERATURE CHARACTERISTICS ARE YF UNLESS OTHERWISE NOTED.

| | |
|-------------------------|-----------|
| TITLE SWR PCB | |
| PARTS ASSEMBLY TOP VIEW | |
| DRAWING NO. | REV. MARK |
| E24-8321 | |

UT550C/PB153AA::24:1

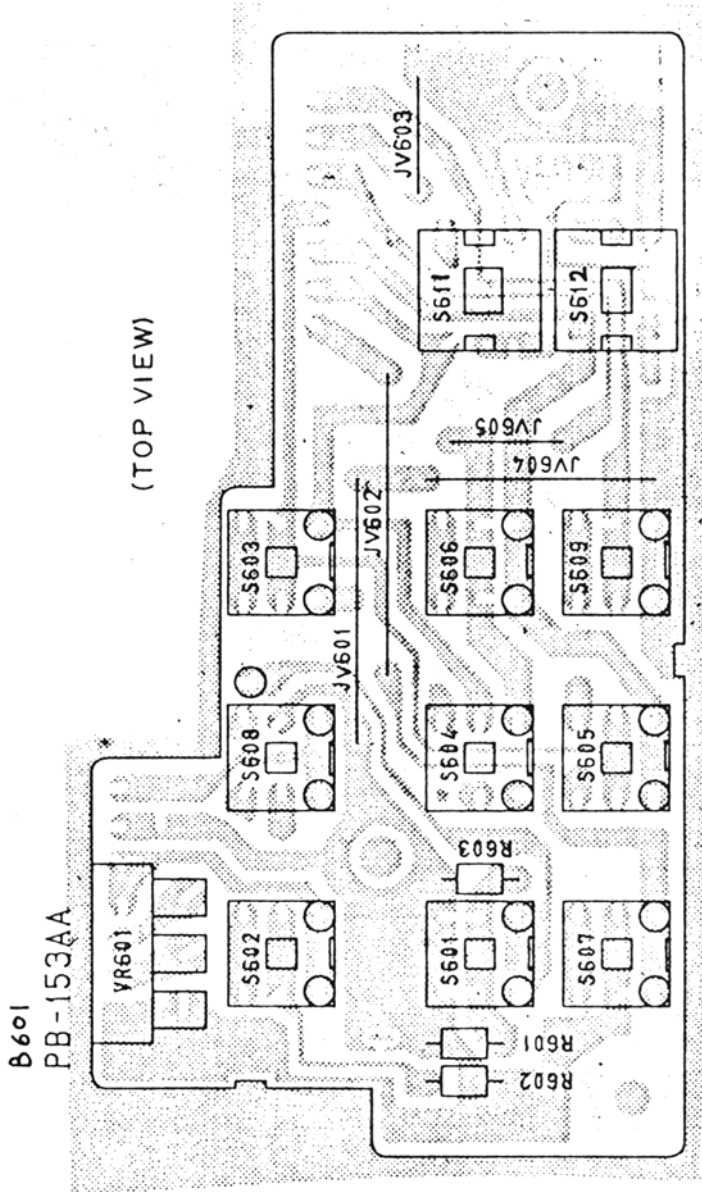

| | | | |
|------|-------|------|-----|
| S601 | SW549 | R601 | 47 |
| S602 | SW549 | R602 | 150 |
| S603 | SW629 | R603 | 47 |
| S604 | SW629 | | |
| S605 | SW629 | | |
| S606 | SW629 | | |
| S607 | SW549 | | |
| S608 | SW549 | | |
| S609 | SW549 | | |
| S611 | SW560 | | |
| S612 | SW560 | | |

| | |
|-------|-----------|
| JV601 | 17.5mm |
| JV602 | 20mm |
| JV603 | 7.5mm |
| JV604 | 15mm |
| JV605 | 7.5mm |
| | |
| | |
| VR601 | RV672 5KB |
| | |

NOTES:
 1. RESISTANCE VALUES ARE SHOWN IN OHMS UNLESS OTHERWISE NOTED, (K=KILO OHM, M=MEG OHM)
 2. RESISTOR WATTAGES ARE 1/6W UNLESS OTHERWISE NOTED.
 3. CAPACITANCE VALUES ARE INDICATED IN MICRO FARADS UNLESS OTHERWISE NOTED, (P=MICRO-MICRO FARAD)

| | |
|----------------|----------|
| TITLE | SW PCB |
| PARTS ASSEMBLY | TOP VIEW |
| DRAWING NO. | E24-8322 |

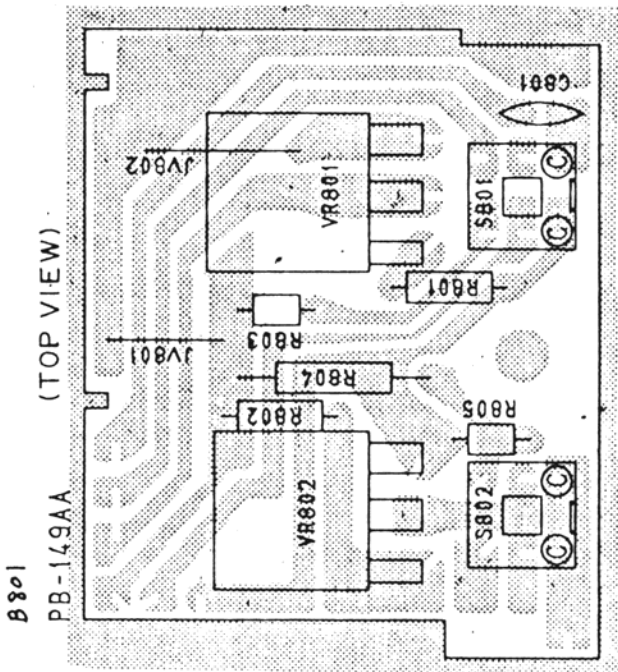

| | |
|------|-------|
| S801 | SW549 |
| S802 | SW549 |
| | |
| | |

| | |
|------|------|
| R801 | 2.2K |
| R802 | 1K |
| R803 | 1K |
| R804 | 5.6K |
| R805 | 4.7K |
| | |
| | |
| | |

| | |
|-------|------------|
| VR801 | RV652 1KB |
| VR802 | RV679 10KB |
| | |
| | |

| | |
|-------|-------|
| JV801 | 7.5mm |
| JV802 | 10mm |
| | |
| | |

| | |
|------|------------|
| C801 | 0.022 (SR) |
| | |
| | |
| | |

- NOTES:
1. RESISTANCE VALUES ARE SHOWN IN OHMS UNLESS OTHERWISE NOTED. (K=KILO OHM, M=MEG OHM)
 2. RESISTOR WATTAGES ARE 1/6W UNLESS OTHERWISE NOTED.
 3. CAPACITANCE VALUES ARE INDICATED IN MICRO FARADS UNLESS OTHERWISE NOTED. (P=MICRO-MICRO FARAD)

| | |
|-------------------------|----------|
| TITLE | RIT PCB |
| PARTS ASSEMBLY TOP VIEW | |
| DRAWING NO. | E24-8323 |

B701 PB-114AB (SQ PCB)

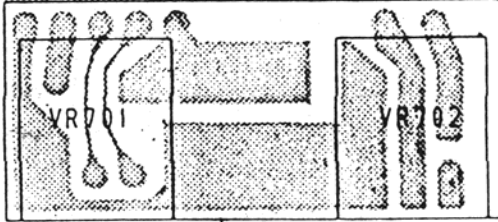

| | |
|-------|------------|
| VR701 | RV677 50KA |
| VR702 | RV678 50KB |
| | |
| | |

B901 PB-115AA (CH SW PCB)

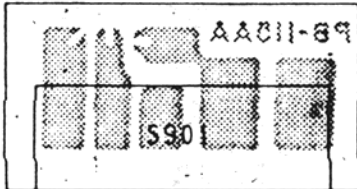

| | |
|------|-------|
| S901 | SR404 |
| | |
| | |
| | |

B911 PB-116BA (MODE SW PCB)

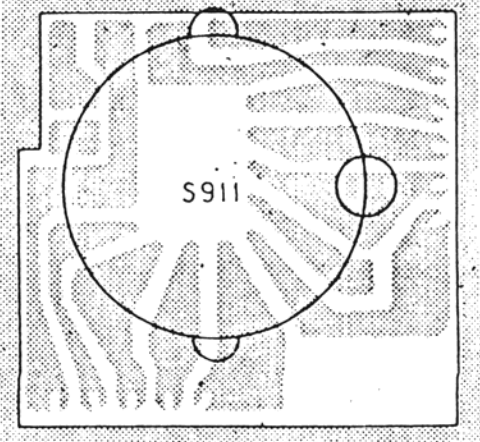

| | |
|------|-------|
| S911 | SR405 |
| | |
| | |
| | |

B651 PB 126AB (MIC PCB)

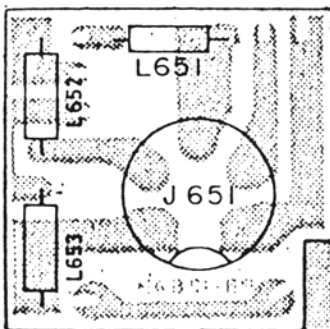

| | |
|-------|-------------------|
| J 651 | JK191 |
| L 651 | LZ051 470 μ H |
| L 652 | LZ051 470 μ H |
| L 653 | LZ051 470 μ H |

NOTE:
1. RESISTANCE VALUES ARE SHOWN IN OHMS UNLESS OTHERWISE NOTED. (K=KILD OHM. M=MEG OHM)

| | |
|----------------------------------|--------------|
| TITLE PARTS ASSEMBLY TOP VIEW | |
| E24-8324 | REV. MARK |
| | |