

This Information Is Provided By
CBTricks.com

SBE SB-34 Service Manual

Liability of damages to any equipment is the sole responsibility of the user! Downloading, viewing, or using any information provided on these pages automatically accepts the user to the terms of this agreement!

Modifications are provided for information purposes only!

Supporters of CBTricks.com paid for the hosting so you would have this file.

CBTricks.com is a non-commercial personal website was created to help promote the exchange of service, modification, technically oriented information, and historical information aimed at the Citizens Band, GMRS (CB "A" Band), MURS, Amateur Radios and RF Amps.

CBTricks.com is not sponsored by or connected to any Retailer, Radio, Antenna Manufacturer or Amp Manufacturer, or affiliated with any site links shown in the links database. The use of product or company names on my web site is not endorsement of that product or company.

The site is supported with donations from users, friends and selling of the Site Supporters DVD's to cover some of the costs of having this website on the Internet instead of relying on banner ads, pop-up ads, commercial links, etc. Thus I do not accept advertising banners or pop-up/pop-under advertising or other marketing/sales links or gimmicks on my website.

ALL the money from donations is used for CBTricks.com I didn't do all the work to make money (I have a day job). This work was not done for someone else to make money also, for example the ebay CD sellers.

All Trademarks, Logos, and Brand Names are the property of their respective owners.

This information is not provided by, or affiliated in any way with any radio or antenna Manufacturers.

Thank you for any support you can give.

For information on how to Support CBTricks.com

<http://www.cbtricks.com/support/>

OPERATION and MAINTENANCE MANUAL

SB-34 SINGLE SIDEBAND TRANSCEIVER



SBE SIDEBAND
ENGINEERS

220 AIRPORT BOULEVARD WATSONVILLE, CALIFORNIA 95076

SBE WARRANTY

The Sideband Engineers equipment described herein is sold under the following guarantee:

SBE agrees to repair or replace, without charge, any equipment, parts, or accessories which are defective as to workmanship or materials and which are returned to SBE at its factory or an authorized warranty station, transportation prepaid, provided:

1. Notice of the claimed defect is given SBE or an authorized warranty station, or an authorized Distributor, in writing, within 90 days from the date of purchase and goods are returned in accordance with SBE instructions.
2. The warranty registration card has been filed within 10 days from date of purchase.
3. Equipment, accessories, tubes, semi-conductors and batteries not manufactured by SBE or from SBE designs are subject to only such adjustments as SBE may obtain from the supplier.
4. Failures due to use of equipment for purposes other than normal amateur operation or in violation of the SBE instruction manual shall not be deemed a defect.

This Warranty is not valid if the equipment is altered, modified or repaired by persons other than SBE or an authorized warranty station. Alteration or modification in accordance with SBE Service Bulletins shall not affect this Warranty.

SBE reserves the right to make any change in design or to make additions to, or improvements in SBE products without imposing any obligation upon SBE to install them in previously manufactured SBE products.

No other warranties, express or implied, shall be applicable to this equipment, and the foregoing paragraphs shall constitute the Buyer's sole remedy under the agreements contained in this Warranty. In no event shall SBE have any liability for damages, loss, or expense directly or indirectly arising from the use of the product, or any inability to use them either separately or in combination with other equipment or from any other cause.

For Warranty Service see inside back cover.

TABLE OF CONTENTS

I.	GENERAL DESCRIPTION	1
II.	SPECIFICATIONS	2
III.	INSTALLATION	
	1. General	2
	2. Fixed Station	2
	3. Antenna	3
	4. Linear Amplifier	3
	5. Mobile Operation	3
IV.	OPERATION	
	1. Control Functions	4
	2. Receiver Operation	7
	3. Transmitter Tuneup	8
V.	THEORY OF OPERATION	10
	1. Transmit Function	11
	2. Receive Function	13
	3. Keying Circuit	14
	4. Power Supply	14
	5. Pitch Control	15
VI.	TROUBLESHOOTING	
	1. Carrier Balance	16
	2. Low Transmitter Output	16
	3. Low Receiver Sensitivity	17
VII.	ALIGNMENT	
	1. Equipment Required	17
	2. Alignment Procedures	17

Transistor Voltage Chart
Tube Voltage Chart
Warranty
Schematic
Component Location Drawings
Block Diagram

I. GENERAL DESCRIPTION

The Sideband Engineers Model SB-34 is a single-sideband, suppressed-carrier transceiver intended for operation in the A3 portions of the U.S. 80, 40, 20 and 15-meter amateur bands. The SB-34 operates either upper or lower sideband; selection is made by a front-panel switch. There is no carrier shift when emission is changed from one sideband to the other. Peak effective power output exceeds 60 watts on the 80, 40 and 20-meter bands, and 50 watts on the 15-meter band.

The SB-34 is self-contained, requiring only a microphone and an antenna for operation. The SB-34 will operate from either a 117-volt AC, or 12-volt DC (negative ground) power source; the two-way power supply is an integral part of the unit. Selection between the two power sources is automatically made when the proper line cord is connected.

Provisions are made for the use of a VOX unit and a 100-kc crystal calibrator which are available as accessory items. A front-panel switch is provided to control the calibrator unit. An accessory plug is also provided on the rear panel for control of the Sideband Engineers external Linear Amplifier companion unit.

All stages of the SB-34 except the transmitter driver and power amplifier are transistorized. The use of bilateral amplifiers and mixers, which amplify in one direction on transmit and in the other direction on receive, permits the use of a single bandpass circuit train. Duplication of circuitry is eliminated through use of common circuit elements for both receive and transmit functions.

The unique bandswitching and exciter tuning control permits adjustment of both functions with a single front-panel knob. Other controls and adjustments are held to a minimum for simplified operation. Exceptional receiver performance is obtained through the use of post-alloy diffused transistors and a 2.1-kc Collins mechanical filter. A pitch control is provided for tuning the receiver approximately 500 cycles either side of the transmitted frequency. The control may be disabled and the receiver locked to the transmitted frequency. A stand-by switch is also provided to turn off the transmitter-tube heaters and the high-voltage power supply during mobile operation. With this switch off, power drain from the car battery is reduced to 0.6 amps.

The entire transceiver package is less than one-half cubic foot in volume and weighs approximately 18 pounds. Construction of heavy-gauge steel and aluminum, and extensive use of printed circuit boards, provide an extremely rugged package, virtually immune to the effects of vibration and shock.

II. SPECIFICATIONS

<u>Type of emission:</u>	Single sideband, suppressed carrier, upper or lower sideband selectable from front panel
<u>Frequency range:</u>	3.775 - 4.025 mc, 7.05 - 7.3 mc, 14.1 - 14.35 mc, 21.25 - 21.45 mc
<u>Power consumption:</u>	117 VAC - receive 35 watts - transmit (single tone) 165 watts 12 VDC - standby 0.6 amps - receive 3.6 amps - transmit (single tone) 14 amps
<u>Power output (PEP):</u>	80, 40, 20 meters: 60 watts minimum 15 meters: 50 watts minimum
<u>Carrier suppression:</u>	50 db
<u>Unwanted sideband suppression:</u>	40 db at 300 cycles
<u>Distortion products:</u>	Down at least 25 db
<u>Spurious responses:</u>	Down at least 40 db
<u>Antenna output impedance:</u>	40 - 100 ohms, unbalanced. VSWR not to exceed 2:1
<u>Sensitivity:</u>	Less than 1 microvolt for 10 db signal-to-noise ratio
<u>Selectivity:</u>	2.1 kc at 6 db down, 4.5 kc at 60 db, both transmit and receive
<u>Audio output:</u>	2.0 watts at 10% distortion, 3 watts maximum
<u>Dimensions:</u>	5" high, 11-1/8" wide, 9-1/2" deep
<u>Weight:</u>	Approximately 18 pounds

III. INSTALLATION

1. GENERAL

The SB-34 transceiver is designed to provide a complete single-unit installation for fixed, portable, or mobile operation. No special precautions need be observed in the choice of location provided adequate ventilation space is available. A minimum of two inches of air space above the cabinet top and on all sides is recommended to allow proper air flow around the top and bottom of the cabinet. Do not place the unit on a car seat or similar surface which may block ventilation through the bottom. Never stack other units above or below the cabinet since the accumulated heat could cause permanent damage.

2. FIXED STATION

Plugging the 117-volt AC power cord into the receptacle at the rear of the transceiver connects all power circuits for 117 volt AC operation. The set

should be connected to a good water-pipe ground. The ground may be connected either to the external speaker terminal labelled GND or to the braid of the antenna cable.

3. ANTENNA

Results both in receiving and transmitting will depend largely on the antenna; the receiver is particularly sensitive to the type of antenna used. Any of the common antenna systems designed for use on the high-frequency amateur bands may be used with SB-34 provided the input impedance of the antenna system is within the capability of the pi-output matching network (40 - 100 ohms resistive). If tuned open-wire transmission line is used, or if a long wire antenna is desired, a suitable antenna tuner must be used between the transceiver and the antenna to provide an impedance match between the unbalanced coaxial output and the balanced open-wire line or long wire.

4. LINEAR AMPLIFIER

The SB-2 LA linear amplifier has been designed for use with the SB-34 and matches the SB-34 in physical appearance. The required switching and control circuits are incorporated. In addition, the SB-34 transceiver may be operated in conjunction with other conventional linear amplifiers. A plug on the rear panel provides a 12-volt DC potential for actuating the control relays of the amplifier selected when the transceiver switches to transmit. If the linear amplifier relays are not intended to operate from such a voltage, an intermediary relay must be used. Any 12-volt relay may be used provided the coil resistance is 100 ohms or more.

5. MOBILE OPERATION

The SB-34 will operate satisfactorily from any 12-volt negative-ground battery source by connecting the DC power cord to the rear-panel receptacle. Due to the unusually small size of the SB-34, under-dash mounting is possible in many cars with limited available space. The Model SB-2 MB Mounting Bracket is available as an accessory.

When making connections to the car battery, be certain that the RED lead is connected to the positive (+) terminal and the BLACK lead to the chassis ground (-); reversed connections could permanently damage the transceiver. It is strongly recommended that the red lead be connected directly to the battery and not to the ammeter or an accessory terminal.

Note: Prior to operating the SB-34 in a mobile installation, the automobile voltage regulator setting should be checked. Many times, even in new cars,

the regulator is adjusted for an excessively high charging voltage. In addition to being injurious to the car battery, this high voltage could cause permanent damage to the SB-34. Make certain before operating that the voltage, when charging, does not exceed 14.6 volts.

Most of the commonly used mobile antennas will give excellent results with the SB-34. Make certain that the outer braid of the coaxial cable is securely grounded to the chassis at the antenna mount.

Noise generated by the ignition system, generator, etc., will usually interfere with weak-signal reception, especially on the higher-frequency bands. Since procedure for eliminating this noise varies with different makes and models of cars, no specific instructions for noise reduction can be given here. Valuable noise reduction information is given in the Amateur Mobile Manuals and these publications should be consulted or one of the several ignition noise suppression kits available should be considered.

If a mobile installation of higher power is desired, the Sideband Engineers companion Linear Amplifier is recommended for use with the SB-34. A special solid-state inverter is available for use with the amplifier to provide a practical 1000-watt mobile installation. Contact your dealer or Sideband Engineers for further particulars.

IV. OPERATION

NOTE: The SB-34 transceiver has been specifically designed to provide the utmost ease of operation and adjustment. All panel controls have been thoroughly tested before shipment from the factory. Several of the controls are unusual in operation, however, and improper adjustment may result in signals of poor quality, and even out-of-band operation. Read this section carefully before attempting to operate the transceiver.

1. CONTROL FUNCTIONS

The various front-panel controls and their functions are described in detail in the following paragraphs. Make certain that you understand the function of each control before attempting to operate the transceiver. Detailed instructions are given for tuning the transmitter. The design of the unit is such that when the transmitter is properly tuned, the receiving portion of the set is also properly aligned to the frequency in use.

1.1 Volume Control. The power ON/OFF switch and volume control functions are combined on a single control knob located at the lower left corner of the

front panel. Operating the knob clockwise beyond the click turns the unit on. Since the receiver portion of the unit is completely transistorized, no warm-up period is required.

A unique AGC system is incorporated in the SB-34. As the volume control is advanced, strong AGC action occurs as the set reaches normal room volume. From this point on, the volume remains substantially constant until the control is about three-quarters advanced. Beyond this point, the volume rises rapidly until full audio output is obtained with the control fully clockwise. For home use, the volume control is normally operated in the first half of its range. With mobile operation, where more audio output is usually required, the control is advanced into the second half of its range. Keeping the volume control at a low, but comfortable, level will reduce the "pumping" action that may occur on SSB signals.

1.2 Tuning Knob. The large knob directly below the dial window controls the actual frequency of operation after the desired band has been selected. A dual-speed reduction drive is incorporated to provide a slow tuning rate and, at the same time, to cover the entire band rapidly. In operation, the knob is turned to the desired portion of the frequency band and slightly past the desired frequency. When the knob rotation is reversed, the vernier action is increased by six for one complete revolution. Further rotation again engages the quick drive action. Since the tuning rate, in slow drive, is 14 kc per revolution, there is no critical "feel" to the dial. An additional feature of this mechanism is that the dial is positively locked to prevent mechanical frequency drift under vibration.

1.3 Microphone Connector. The microphone jack is located at the lower center of the panel. The jack accepts a type PL-68 (small diameter) plug with the microphone connected to the sleeve and the push-to-talk switch connected to the tip. The SB-34 transceiver is designed to operate with a medium or high-impedance dynamic microphone such as the SBE Model SB2-MIC. Crystal or ceramic microphones will give poor results unless an auxiliary pre-amplifier is used, because of the very high impedance of the microphone and the low-impedance transistor microphone amplifier. In addition, the rising characteristic of this type of microphone combined with the narrow bandpass of the mechanical filter employed in the SB-34 produces a somewhat unpleasant sound to the average voice. Carbon microphones will operate only if external provisions are made for supplying them with operating current.

1.4 Bandswitch. The bandswitching and exciter tuning functions are combined in a single knob located just below the meter. With the knob indication fully clockwise, the transceiver is set for 80 meters, and the front end of the receiver is peaked by rotating the knob through the arc labelled "80". Correct tuning is indicated by a sharp rise in background noise similar to that obtained

with the "antenna tuning" control on a conventional receiver. To change to 40 meters, the knob is rotated counter-clockwise beyond the 80-meter arc. A click will be heard between the 80 and 40-meter arcs. This is the bandswitch operating to the 40-meter position. Tuning is again performed by rotating the knob within the 40-meter arc for a sharp rise in noise. This is progressively repeated for operation on the 20 and 15-meter bands. A stop is provided at the extreme counter-clockwise end of rotation past the 15-meter arc. **WARNING!** Do not attempt to move the knob past this stop! Damage may result. The knob may slip and cause loss of calibration. If this should happen, turn the band-switch knob fully clockwise, loosen the set screws and set the knob index exactly on the clockwise stop mark on the panel. Tighten the set screws securely. Further adjustment of the bandswitch knob is covered in the TRANSMITTER TUNEUP section.

1.5 Pitch Control. The pitch control, located to the right of the volume control, provides a means for tuning the receiver frequency slightly to either side of the transmitting frequency. Thus, it is possible to set the pitch of the voice you are receiving to the most readable point without affecting your transmitting frequency. Its use is particularly valuable in "net" contacts where several of the participants may be transmitting slightly off frequency. The pitch control may be switched off and the receiver locked to the transmitting frequency by operating the PITCH switch (between the volume control and the pitch control) to the OFF position. Normally, you will want to keep the pitch control turned off until the initial contact is made. After accurately zeroed with the other station, the pitch control may be used to correct for any drift at the other end of the contact. This technique prevents the "leap-frogging" so prevalent with transceivers.

1.6 Dial Correct. The dial correct knob, located to the right of the dial window, is used to adjust for any error in dial calibration. The transceiver is aligned at the factory for correct dial readings with the correct knob index straight up. If an accurate calibration signal is not available, the correct knob should be left in this position. An accessory 100-kc calibrator unit is available for accurately setting the dial. Alternately, the dial can be corrected on a signal of known accuracy. The use of other amateur signals for this purpose is, in general, not advisable. The calibration of many amateur transmitters is subject to question.

1.7 USB/LSB Switch. This switch sets the transceiver to receive and transmit on either the upper sideband or the lower sideband. In general, it is common practice to use lower sideband on 80 and 40-meter band frequencies, and upper sideband on 20 and 15-meter frequencies. However, occasionally you will find exceptions. If the signal cannot be made intelligible by any amount of tuning, it is probably transmitting the sideband opposite to that which is selected on the USB/LSB switch. Changing the position of this switch does not disturb the dial calibration and no retuning is required.

1.8 CAL Switch. This switch controls the 100-kc calibrator unit which is an accessory item. Moving the switch up to the ON position inserts a beat signal every 100 kc on all bands.

1.9 XMTR Switch. With this switch in the down position, the transmitter tube heaters and the high-voltage supply are turned off when the transceiver is operating mobile. This reduces battery drain to 0.6 amps and thus permits long periods of listening without fear of excessive battery drain. Operating the switch to the ON position actuates the high-voltage supply and the tube heaters. An audible hum from the built-in DC power supply transformer will be evident with the switch in the ON position; however, the hum level is low and will not interfere with the reception of a signal in the normal mobile environment. After a 30-second warm-up period, the transmitter is ready for operation. The XMTR switch operates only when the set is powered from a 12-volt DC battery; it does not function with 117-volt AC operation. With 117 volts AC, the heaters and high voltage supply are energized at all times.

1.10 PA TUNE. The PA TUNE control is intended primarily for loading the transmitter to the antenna. However, for maximum receiver sensitivity, it must be set to the point which is correct for transmitting. If the transmitter section is not being operated, adjust the PA TUNE control for maximum receiver volume with the PA LOAD capacitor set at one turn back from maximum clockwise position. Otherwise, see TRANSMITTER TUNEUP section.

1.11 Transmitter Controls. The controls used exclusively in transmitting are: MIC GAIN, PA LOAD, METER Switch, and TUNE-OPER Switch. Their use is described in the TRANSMITTER TUNEUP section.

2. RECEIVER OPERATION

The SB-34 transceiver employs a 2.1 kc Collins mechanical filter to attain exceptional selectivity on both receive and transmit. The unit is designed to pass only that portion of the voice spectrum falling between 300 and 2400 cycles. Experience has shown that this bandwidth permits excellent intelligibility and still discriminates against interfering noise. Since the transceiver audio system and speaker is also carefully shaped to pass only 300 to 2400 cycles, the end result is reception similar to the quality of a conventional telephone. No adjustment of the transceiver will produce "high fidelity" reception in the normal sense. The SB-34 will, however, provide good communications under conditions of high noise and weak signals when conventional receivers with extended audio range and wide bandpass are completely unusable.

Considerable effort has been expended to prevent the receiver from overloading or blocking on strong signals. Since the volume control mainly affects the

RF section of the receiver rather than the audio circuits as is customary, the receiver is less likely to overload at low volume settings than at a high setting. Quite often interference from close-by stations can be completely eliminated by merely reducing the volume control setting. An automatic gain control system (AGC) is incorporated in the transceiver. It provides strong compression on signals when the audio output exceeds one-quarter watt (normal room volume). If more audio is required, as when operating mobile, turning the volume control into the upper half of its range increases the audio output to a maximum of three watts.

A few spurious responses (birdies) may be noted as the receiver is tuned through the various bands. With a normal antenna and in an average location, all of these responses will be below the level of a readable signal, with the exception of a single response at 7300.8 kc. Since this response is outside the amateur band, it should cause no inconvenience to the operator. It is, in fact, useful as a means of checking the dial accuracy, since it has the stability of the carrier oscillator and may be relied upon to be accurate as a frequency marker.

3. TRANSMITTER TUNEUP

NOTE

Improper transmitter tuning can result in serious distortion and possibly operation outside the band. Improper adjustment of the MIC GAIN control can cause "flat-topping" and the generation of splatter and other spurious emissions. Make certain you understand the following instructions thoroughly before attempting to operate the transmitter.

Transmitter tuneup consists of adjusting the exciter, loading the power amplifier to the antenna, and setting the microphone gain control for optimum power output without distortion. The SB-34 has been carefully designed to minimize the possibility of improper operation due to faulty tuning procedures, and to make the tuneup process as simple and quick as possible.

The combination bandswitch and driver tuning, for instance, has been arranged to preclude the possibility of tuning up on incorrect frequencies. It is, however, possible to transmit a poor signal if the set is not correctly tuned. Take the time to memorize the following step-by-step procedure and your SB-34 will always transmit a clean, powerful signal that will be a credit to your station.

3.1 Power Amplifier and Driver Tuning. With the transceiver turned on, allow 30 seconds for warm-up of the transmitter tubes. Make certain an antenna

resonant to the band in use is connected. Set the controls as follows:

1. TUNE-OPER - to OPER.
2. DIAL CORRECT - center of range.
3. PITCH - off.
4. METER - Ip (in this function meter indicates
PA plate current x 100 ma (0-500 ma).
5. Band Selector - to desired band.
6. Tuning Knob - to desired frequency.
7. PA TUNE - full counter-clockwise (max. capacity).
8. PA LOAD - full counter-clockwise (max. capacity).
9. MIC GAIN - full counter-clockwise (min. gain).

3.1.1 Adjust the bandselector knob within the arc of the band selected for maximum receiver noise.

3.1.2 Set the TUNE-OPER switch to the TUNE position. The receiver will "quiet" and the meter will indicate PA plate current.

3.1.3 Carefully re-adjust the band selector knob for maximum meter indication. This will occur at a setting very close to that which produced maximum receiver noise. One or more peaks may be evident if the band selector knob is tuned through the entire arc, but the correct setting will always be near the point of maximum receiver noise, and will always produce a much higher meter reading.

3.1.4 Turn the PA TUNE control clockwise until a sharp dip in meter indication occurs.

3.1.5 Set meter switch to ANT. In this function, the meter measures voltage across the antenna circuit and the amplitude of the readings will be dependent on the actual antenna circuit impedance. The meter, therefore, should be used only as an indicator of optimum transmitter tuning into the particular antenna.

3.1.6 Turn the PA LOAD control clockwise for maximum (peak) meter reading. NOTE: The PA LOAD control is a mica compression trimmer. This control rotates at least four full turns to go from minimum to maximum capacity.

3.1.7 Re-adjust PA TUNE control for maximum (peak) meter reading.

3.1.8 Repeat steps 3.1.6 and 3.1.7 until the meter reads maximum possible, with final adjustment being the PA TUNE control.

(If it is not possible to tune through a peak meter reading when adjusting the PA TUNE or PA LOAD control, the antenna system presents an input impedance

which is beyond the matching capabilities of the pi-network (40-100 ohms resistive) and the antenna system should be checked).

3.1.9 Switch meter back to Ip, note meter reading and return TUNE-OPER switch to OPER. Normal plate current should be 200 to 250 ma.

3.2 MIC GAIN Adjustment. Turn the METER switch to Ip position and the TUNE-OPER switch to TUNE long enough to note the meter reading.

With the transceiver properly tuned to a resonant antenna, the reading should be between 2.0 and 2.5. (In mobile operation with the engine off during tune-up, this reading may be slightly lower.) Return the TUNE-OPER switch to OPER, press the microphone button and speak a steady "Ahhh" into the microphone at the level and distance you intend to use when transmitting. Gradually turn the MIC GAIN control clockwise until the meter reading increases to approximately 1.5 if the maximum reading was 2.5; or 1.3 if the maximum reading was 2.0. This setting of the MIC GAIN control will ensure a strong transmitted signal without danger of overdriving.

NOTE

It is very important that the MIC GAIN control be correctly set. If it is too high, excessive distortion will be produced. On the other hand, too low a setting will result in low transmitter output. On-the-air reports should be taken with caution since they are subject to many inaccuracies.

V. THEORY OF OPERATION

The SB-34 single sideband transceiver is essentially bilateral. With the exception of the receiver RF amplifier and the high-level transmitting stages, the signal stages may amplify in either direction. During the receive function they amplify in one direction, on transmit they amplify in the opposite direction. The same tuned circuits are used for both transmitting and receiving. The various injection oscillators operate continuously, supplying the local oscillator signals to the proper mixer stages.

All transistors in the transceiver operate in the common emitter configuration except the receiver RF amplifier Q11. This stage operates common base.

A typical bilateral stage may be understood by referring to the 456 kc amplifier Q5-Q6 in the schematic diagram. With the microphone button released, the base bias resistor of Q5 is returned to a line which carries a +12-volt

potential. The transistor cannot conduct. The base bias resistor of Q6, however, is returned (through the volume control) to a line which is essentially ground potential with the microphone button released and Q6 is in conduction and able to amplify. Thus, with the microphone button up, a signal appearing at the mechanical filter will be amplified and delivered to IF transformer T2. With the microphone button pressed, the two bias-control lines are inverted in polarity so that Q6 is cut off and Q5 is able to conduct. Therefore, a signal appearing at T2 is amplified by Q5 and impressed on the filter. Similarly, the amplifying direction of the VFO mixer Q7-Q8, and the high-frequency mixer Q9-Q10 are controlled by the two bias control lines.

Unilateral stages that are required to operate only on receive or transmit are turned off when not needed by returning their base bias resistors to the appropriate bias control line. The transmitter tubes are disabled during receive by applying a high negative bias to their grids.

1. TRANSMIT FUNCTION

An audio signal from the microphone, controlled in amplitude by the MIC GAIN control, is amplified by the microphone amplifier Q4 and applied to the ring-balanced modulator CR3-7. Crystal oscillator Q12 operating at 456.38 kc, provides a carrier to the modulator. Carrier balance is obtained by a potentiometer and a trimmer capacitor. Double-sideband, suppressed-carrier output from the balanced modulator is amplified through T2 by the bilateral amplifier Q5-Q6. The amplified signal is then passed through the mechanical filter which suppresses the upper sideband.

Output from oscillator Q12 is also applied to frequency doubler CR8. The doubled carrier frequency from this stage is then either doubled again or tripled by Q13. With the mode selector switch set at USB, the frequency is tripled; with the switch on LSB the frequency is doubled. Thus, on USB, a 2738.2 kc (456.38×6) signal appears at the output of T5. On LSB an 1825.5 kc (456.38×4) output appears at T5.

Doubler/tripler transformer T5 is connected in a ring with the mechanical filter, mixer CR9, and transformer T3 which is tuned to 2281.9 kc. With the mode selector in LSB, output from T5 is additively mixed with the lower-sideband signal from the filter to produce a lower sideband signal at 2281.9 kc. With the mode selector set on USB, the T5 output is subtractively mixed with the filter output to generate an upper-sideband signal, still at 2281.9 kc. Thus, the mode selector, by adjusting Q13 to either double or triple, determines the mode of the sideband signal. Since all of the frequencies involved are derived by a single oscillator, no shifting of carrier frequency can occur and no retuning is necessary when switching sidebands.

With the TUNE-OPER switch in TUNE position, a measured amount of carrier signal is inserted in the DC load resistor of mixer CR9 for transmitter tune-up purposes only. NOTE: Power output measured in the TUNE position with a power meter is not indicative of the PEP output of the transmitter.

The 2281.9 kc upper or lower sideband output from T3 is applied to VFO mixer Q7-Q8. Also applied to this mixer is an injection signal which is tunable from 5456.9 kc to 5706.9 kc. This injection is generated by VFO Q15 and isolated from the load by VFO buffer Q14. Tunable IF transformer T6, connected to the output of VFO mixer Q7-Q8, tunes the frequency range 3175 through 3425 kc. This frequency range is the result of subtractively mixing the incoming 2281.9 kc sideband signal with the VFO injection. Transformer T6 is ganged-tuned with the VFO and thus is always accurately tuned to the desired frequency.

The 3175 kc to 3425 kc sideband signal from Q7-Q8 is applied to high-frequency mixer Q9-Q10. Also applied to this mixer is an injection from high frequency crystal oscillator Q19. The frequency generated by this oscillator may be 7200, 10475, 17525, or 24625 kc depending upon the position of the bandswitch. Here again, the 3175-3425 kc incoming signal is subtractively mixed to produce the final output frequency. Output from mixer Q9-Q10 appears across tuner coil L2. The resonant frequency of L2 is controlled by a large variable capacitor and a special slug which penetrates into the coil an amount depending upon the setting of the bandswitch. The large variable capacitor is mechanically linked to the bandswitch through a Geneva movement so that rotating the capacitor shaft tunes the coil through a limited range bracketing the selected operating band. Changing the bandswitch to the next band tunes a limited range bracketing this band, etc. On 80 meters, the slug is almost fully penetrated into the coil and the capacitor is near maximum capacity. On 40 and 20 meters, the slug and capacitor are at near mid-range, and on 15 meters the slug is fully withdrawn and the capacitor is near minimum. By this unique method of tuning and bandswitching, the Q and inductance/capacitance ratio of L2 and the variable capacitor are near optimum on all bands, and the resonant impedance remains essentially constant across the entire tuning range. This tuning is ganged with, and duplicated in, antenna coil L3 and driver coil L7 which results in exciter train tuning with only one control.

The single-sideband suppressed-carrier final output signal from L2 is applied to the grid of transmitter driver V1 where it is amplified, and appears across L7. A low-impedance winding on L7 couples the signal to the paralleled grids of power amplifier V2 and V3. Neutralization of the power amplifier is accomplished by feeding back a small amount of the output through Cn to the top of L7 with the low-impedance winding providing the necessary phase reversal.

Final output from V2 and V3 is fed to a pi-section network consisting of L9 and the PA TUNE and PA LOAD capacitors. A section of the bandswitch adjusts the

inductance of L9 to the correct value for each band, and also adds fixed amounts of capacity to both the PA LOAD and PA TUNE capacitors on 80 meters.

2. RECEIVE FUNCTION

With the microphone button released, a signal from the antenna is loosely coupled from the transmitter pi-section net to the top of L3. Diodes CR14 and CR15, across L3 conduct only when extremely strong signals are present and do not otherwise affect the circuit. The signal at L3 is coupled to the emitter of Q11 which operates as a common-base amplifier. The amplified signal from Q11 is applied to high-frequency mixer Q9-Q10 through L2. With injection from Q19, this stage converts the signal to a frequency within the range 3175-3425 kc. The converted signal is then mixed by Q7 and Q8 to 2281.9 kc with injection from the VFO Q14 and Q15. The converted signal is finally mixed by diode CR9 to the 456.38 reference frequency in a manner exactly opposite to that described for this stage during the transmit function. Output from the filter is then amplified by Q5 and Q6 and coupled through T2 to the ring modulator CR3-CR7.

With BFO injection from the carrier oscillator, the ring modulator now functions as a detector, and produces an audio output which is applied to the base of Q2. Output is taken from the collector and coupled to audio driver Q1. This stage, in turn, drives the audio power amplifier Q20 which increases the signal to speaker level.

The VOLUME control sets the gain of the high-frequency mixer, the 456 kc amplifier and, to a small extent, the first audio amplifier, Q2. Other signal stages operate at full gain except in the presence of AGC action.

RF amplifier Q11 and IF amplifier Q5-Q6 are gain controlled by AGC amplifier Q3. An audio signal appearing across the speaker terminal causes Q3 to conduct heavily. The voltage at its collector is normally close to that of the supply, +12 volts. When Q3 conducts, however, the collector potential falls rapidly and charges the 250-mfd capacitor (connected between collector and the 12-volt bus) to some value less than 12 volts. This AGC voltage is connected to the emitters of the RF amplifier and the 456 kc amplifier, and as the AGC voltage falls toward ground potential, the gains of these stages are reduced until the audio output is stabilized. The AGC action is proportioned such that the RF amplifier becomes largely cut off in the presence of even moderate signals so that following stages are protected from signal overload. If the signal fades, causing the audio output to drop, Q3 conducts less and the 250-mfd capacitor slowly discharges toward the +12-volt potential, causing the stages gains to be restored as necessary to maintain the audio level.

When the VOLUME control approaches the fully clockwise position, diode CR1, connected to the base of Q3, begins to limit the amount of audio applied for AGC action. With this occurring, more audio output is produced for a given amount of AGC. Finally, with the volume control fully clockwise, the base of Q3 is clamped off and full audio output is produced.

Diode CR2, in the collector of Q3, conducts when the unit is switched to transmit. This conduction charges the 250 mfd capacitor to the 12-volt potential so that when the set is switched back to receive, full receiver gain is instantly available.

3. KEYING CIRCUIT

Two transistors, Q16 and Q17, perform the functions necessary to switch the transceiver from receive to transmit, thus eliminating the conventional relay. The base of Q16 is coupled through a current limiting resistor to the cathode of driver tube V1. With the microphone button released, V1 draws no cathode current and its cathode is at ground potential. Q16, therefore, is cut off and the potential at its collector is +12 volts. This potential is supplied to the control line that requires +12 volts on receive. Also, the collector potential at Q16 is applied to the base of Q17 causing this transistor to conduct to saturation. Its collector potential, therefore, is essentially grounded. The control line requiring ground potential on receive is connected to the collector of Q17.

When the microphone button is pressed, the high negative bias on driver tube V1 is removed and the stage conducts. The cathode potential of V1 rises to approximately +6 volts and, with this voltage applied to the base, transistor Q16 conducts to saturation. The control line that was +12 volts on receive is now at ground potential. In addition, since the potential on the base of Q17 is removed, this stage cuts off and the control line that was grounded on receive is now +12 volts.

4. POWER SUPPLY

The SB-34 contains a power supply designed to operate from either 117-volts AC or 12-volts DC (negative ground). Inserting the appropriate power cord into the rear-panel receptacle makes the necessary connections to operate the supply in either mode.

With DC operation, transistors Q21 and Q22 are connected as a common-emitter power oscillator. Starting bias for this oscillator is obtained from a small resistor and the heater current of driver tube V1. All of the transmitter-tube heaters and input voltage to the oscillator are applied through the XMTR switch so that the receiver portion of the transceiver may be operated with reduced

power consumption. A high-voltage winding of T7 is connected to a voltage tripler circuit CR17, CR18 and CR19 to supply approximately +450 volts to the transmitter tubes and +150 volts to the screen grids of V2 and V3. Another small secondary winding is half-wave rectified by CR20 to supply negative bias to the transmitter tubes.

With 117-volt AC operation, T7 is energized by a second primary winding. The feedback and collector windings of the transformer are connected essentially in series and full-wave rectified by the collector-base diodes of Q21 and Q22 to provide a high-current +12 volts output. This voltage is used to operate the transistorized stages and operate the transmitter tube heaters. The high-voltage and bias systems operate as described above. The XMTR switch, in this mode of operation is not connected; the transmitter tube heaters are energized at all times.

A special regulator circuit is provided to stabilize the voltage to the VFO, Q14 and Q15. Regulator Q18 operates as a shunt regulator across the +12 volt bus to provide an output of +7.0 volts. The current to the base of Q18 is determined by the current flow through zener diode CR10, and since this zener diode in itself is not a perfect regulator, the output voltage from Q18 would normally vary slightly as the supply voltage changed. To overcome this variation, a small variable resistor is inserted in the series-dropping resistor line to the regulator transistor. The effect of this variable resistor is to insert an additional amount of base current to the transistor to offset the slight change that occurs in the zener diode due to supply-voltage changes. Thus, with proper adjustment of the resistor, regulation becomes perfect for input supply voltages of 11.5 to 15.0 volts.

5. PITCH CONTROL

The purpose of the PITCH control is to permit slight adjustment in receiver frequency with respect to the transmitting frequency. The control may be switched in or out as desired. A small silicon diode, CR11, is connected between the "hot" end of the VFO coil L5 and a voltage divider network which may be adjusted to a value between the regulated voltage (+7 volts) and ground. The diode is connected so that a reverse bias is applied and therefore appears as a small capacitor, the actual value of capacity being variable depending on the amount of reverse bias applied.

The voltage divider network supplying bias to the diode contains, in one leg, the DIAL CORRECT potentiometer. This leg is active on both transmit and receive. The other leg of the network is divided into two sections, one operating on transmit, the other on receive. On transmit, the leg consists of a 470-ohm resistor and diode CR12 which is arranged to conduct only on transmit. On receive, the leg consists of either an adjustable resistor (when the PITCH

switch is OFF) or the PITCH control (when the PITCH switch is on) and diode CR13 which conducts only on receive.

The overall effect of the PITCH control network is to permit a slight variation in VFO frequency on both transmit and receive by the DIAL CORRECT control, and a variation on receive only by the PITCH control. The adjustable resistor, activated when the PITCH switch is off, is factory set so that the VFO frequency on receive is exactly the same as on transmit.

VI. TROUBLESHOOTING

The SB-34 transceiver has been carefully aligned and tested at the factory, and all adjustments that might become misaligned from the effects of vibration and temperature cycling have been securely locked in place.

Problems that might possibly arise, and their detection and correction, are included in the following paragraphs.

1. CARRIER BALANCE

The SB-34 is designed to maintain carrier suppression of at least 50 db below full output for extended periods of time. If for any reason excessive carrier is present, the carrier balance potentiometer on the rear panel should be re-adjusted. The most accurate method for doing this requires a fairly sensitive vacuum-tube RF voltmeter, such as the Hewlett-Packard HP-410B, or equivalent, connected across the antenna terminals. With the MIC GAIN control set fully counter-clockwise, and the microphone button pressed, the residual carrier, as measured by the voltmeter, should be nulled to a value of 0.2 volts rms, or less, by use of the carrier balance potentiometer. Check operation on both sidebands since there may be a slight difference in carrier between the two modes. Any difference should be averaged out by the potentiometer. If it is not possible to reduce the carrier to a reading of 0.2 volts with the potentiometer alone, remove the set from the cabinet, and readjust the carrier balance trimmer (see top-view layout chart). The trimmer and the potentiometer interact somewhat so that several cycles of adjustment may be required. Note: T2 adjustment can also affect carrier balance.

2. LOW TRANSMITTER OUTPUT

Low transmitter output generally indicates weak tubes. If the off-resonance plate current of the power amplifier stage becomes less than 200 ma, as indicated on the front-panel meter, either the driver or power amplifier tubes may require replacement. If the power amplifier tubes are replaced, re-neutralization may be necessary. The neutralizing capacitor (Cn) must be adjusted with an insulated alignment tool. Proper neutralization is indicated

when maximum output and minimum plate current occur with the same setting of the PA TUNE control. The adjustment should be made with the set tuned for 15-meter operation. (See Section 10.1 for Neutralizing Method.)

3. LOW RECEIVER SENSITIVITY

Since the receive portion of the transceiver is fully transistorized, no loss in sensitivity should be experienced with age. If the receiver seems to be lacking in sensitivity, the RF trimmer and slug (see layout charts) may require touch-up. Make certain that the transmitter is properly tuned to the antenna before making the adjustment. The slug may be reached through the side of the chassis and requires a long screwdriver, completely non-metallic.

Low audio output or distortion may also be traced to leaky or shorted electrolytic capacitors in the audio portion of the receiver or transmitter. These will usually cause abnormal voltage readings at the various stages. Refer to the voltage chart.

VII. ALIGNMENT

WARNING

Dangerous high voltage is present in the equipment whenever the unit is turned on. The high-voltage filter capacitors remain charged at all times and can cause fatal shock under certain conditions. Allow at least five minutes after the unit is turned off for the filter capacitors to discharge. Always remove the line plug from the outlet when servicing the set.

1. EQUIPMENT REQUIRED

For correct alignment, an accurate vacuum-tube RF voltmeter such as the Hewlett-Packard HP-410B, a calibrated audio voltmeter, and a well-calibrated RF signal generator such as the Measurements Model 65B are required. Do not attempt alignment unless accurate equipment is available.

2. ALIGNMENT PROCEDURES

NOTE: Refer to layout charts for location of various components and test points. Use test probes with caution; an accidental short will usually cause permanent damage to transistors.

2.1 Carrier Oscillator. Connect the VTVM to the center arm of the carrier-balance potentiometer, R25. A reading of 1 volt rms or more indicates correct oscillator operation.

2.2 Doubler and Doubler/Tripler Alignment. Connect a VTVM to the cathode of CR9. A reading of 0.5 to 0.6 volts indicates correct operation. Test with USB-LSB switch in both positions. If reading is low, align both slugs of T4 for maximum output. Switch to USB and align both slugs of T5 for best output. Switch to LSB and adjust the two X2 ADJUST trimmers for maximum. If readings are high, detune the bottom slug of T4 slightly until reading is correct. If only the LSB reading is high, detune one of the X2 ADJUST trimmers slightly.

2.3 VFO Alignment. Faulty VFO operation is indicated when dial readings cannot be corrected by the DIAL CORRECT knob, or no receiver operation is obtained on any band. Test for VFO oscillation by connecting the VTVM to the rear lug of the small 3-gang tuning capacitor. A reading of approximately 1.0 volt rms is normal. Test the VFO buffer by connecting the VTVM to the collector of Q14. Adjust the VFO buffer coil L4 for a reading of 0.12 volts rms.

To adjust the VFO frequency, set the DIAL CORRECT knob with pointer up and the PITCH switch to OFF. Tune the receiver to a signal of an accurate, known frequency (or use 100-kc calibrator) and adjust the VFO trimmer, C-54 until the signal is zero beat at the correct dial reading.

2.4 Receiver Zero Adjustment. Loosely couple the antenna lead of a stable full-coverage receiver to L4. Tune the receiver in the range 5.50 - 5.75 mc until the VFO signal is heard. Press the microphone button and accurately zero beat the signal on the receiver. Release the microphone button and adjust the VFO ZERO potentiometer R58 until the signal is again zero beat. Press the button several times and check to see that no detectable shift in VFO frequency occurs between receive and transmit.

NOTE: This adjustment will only hold across the dial if the VFO is properly aligned in accordance with paragraph 2.3 above.

2.5 Crystal Oscillator Alignment. Connect the VTVM to the emitter of either Q9 or Q10. Set the bandswitch to 15 meters. Adjust the slug of L6 for a meter reading of 0.25 volts rms. If this reading cannot be obtained, a reading between 0.2 and 0.3 volts is satisfactory. Now set the bandswitch to 20 meters and adjust the rear crystal trimmer (next to bandswitch) for a meter reading of 0.25 volts. Next, set the bandswitch to 40 meters and adjust the center trimmer for 0.25 volts. Finally, set the bandswitch to 80 meters and adjust the forward trimmer for 0.25 volts.

2.6 Receive RF Amplifier Alignment. Set the bandswitch to 15 meters and adjust pointer to the center of the 15-meter arc. Connect a signal generator to the antenna jack J5 and set for operation at 21.35 mc unmodulated. Reduce the attenuator as required so that an audio output signal of less than 0.25 volts (measured on the rear-panel speaker terminals) is obtained at full volume

control setting. Adjust the PA TUNE and PA LOAD controls for maximum audio output. Then adjust the center trimmer C90-B of the large 3-gang capacitor for maximum audio output. Then set the transceiver to receive on 3.80 mc and adjust the signal generator to 3.80 mc. Reset PA TUNE and PA LOAD controls for maximum audio output. With the attenuator set for an audio output of less than 0.25 volts, set the bandswitch knob index to a point 1/4" from the clockwise edge of the 80-meter arc. Adjust the center slug (L3) on the slug rack for maximum audio output. Use a long, non-metallic screwdriver for this adjustment.

2.7 Transmitter Bias Adjustment. Key transmitter with no drive, METER switch in Ip position. Adjust bias control, located in the upper right corner of the tube compartment, for a meter reading of 100 ma. This sets the final amplifier bias.

2.8 T2 Alignment. Set the transceiver to transmit on 3.80 mc. Connect a suitable 50-ohm dummy load to the antenna jack J5. Also connect the VTVM to the antenna jack. Connect a two-tone test signal into the microphone jack J1 and with the microphone button pressed, tune the transmitter controls for maximum power output with MIC GAIN control advanced slightly. Then reduce the MIC GAIN setting until the output is about 30 volts. Adjust T2 (one slug) for maximum output.

2.9 T3 Alignment. With the conditions set up for Step 2.8, adjust both slugs of T3 for maximum output.

2.10 T6 Alignment. With the conditions set up for Step 2.8, tune the transceiver to 3.90 mc. Repeat the bandswitch knob, the PA TUNE control and the PA LOAD control for maximum output. Then adjust both slugs of T6 for maximum output.

2.11 High-Frequency Mixer Alignment and Transmitter Drive Adjustment. With the conditions set up as in Step 2.8, set the transceiver to transmit at 21.35 mc and adjust the transmitter controls for maximum output. Set the bandswitch knob to the center of the 15-meter arc. With the MIC GAIN control set for an output of about 45.0 volts, adjust the forward trimmer, C90-A, of the large 3-gang capacitor for maximum output. Also adjust the rear trimmer, C90-C, for maximum output. If a large change in this trimmer is noted, it may be necessary to re-neutralize the power amplifier.

2.12 Transmitter Final Amplifier Neutralization. With conditions set up as outlined in Step 2.8, advance the MIC GAIN control until flat-topping occurs. Adjust the neutralizing capacitor C86 until maximum output and minimum plate current occur at the same setting of the PA TUNE control. There is some interaction between the neutralizing capacitor C86 and the drive trimmer C90C;

therefore C90C (rearmost trimmer) should be adjusted for maximum output per Step 2.11 before attempting to adjust the neutralizing capacitor.

2.13 Now set the transceiver to transmit at 3.80 mc and adjust controls for maximum output. Set the MIC GAIN control for about 30-volts output. Set the bandswitch knob index at a point 1/4" from the clockwise edge of the 80-meter arc. Adjust the front slug (L2) of the slug rack for maximum output. Also adjust the rear slug for maximum output.

2.14 Finally, set the transceiver to transmit at 7.20 mc and adjust controls for maximum output, release the microphone button and see that maximum receiver noise occurs at the same setting of the bandswitch knob as transmitter maximum output. If not, adjust the rear slug (L7) very slightly until the two settings are very nearly the same. Check 80-meter operation again and see that the bandswitch knob settings for maximum receiver noise and transmitter output are very nearly the same.

2.15 L10 Alignment. This adjustment reduces the spurious radiation of a signal at 24,625 kc, the frequency of the crystal oscillator when operating on 15 meters. Set for transmit on 21.35 mc and adjust for maximum transmitter output. Then set the MIC GAIN control fully counter-clockwise and adjust the VTVM to read the residual output signal. Slowly turn the PA TUNE control clockwise until a small peak shows on the VTVM. Adjust the slug of L10 for minimum reading. The final reading should be less than 1.0 volt rms. Return the PA TUNE control to the setting for maximum 15-meter output.

2.16 Carrier Balance. After completing Step 2.15, again reduce the MIC GAIN setting to zero. Alternately adjust the Carrier Balance potentiometer R25 and the Carrier Balance trimmer C23 for minimum output. It should be possible to null the carrier to a VTVM reading of less than 0.2 volt with the USB-LSB switch in either position. This completes the alignment procedure. Incorrect adjustment of T2 can affect carrier balance.

2.17 Voltage Regulator Adjustment. R42, the voltage regulator adjustment, has been carefully set at the factory and should not normally be adjusted in the field. If replacement of either Q18 or CR10 necessitates re-adjustment, the following procedure should be used.

Note: In addition to the test equipment listed on the preceding page, a variac will be required for accurate voltage regulator adjustment.

Tune the receiver to a calibrator signal or other stable source. Vary the AC input line voltage between 100 and 120 volts while adjusting R42 for a steady signal. The voltage regulator is properly adjusted when the signal stability is unaffected by the line voltage fluctuations.

TRANSISTOR VOLTAGES

Symbol	Type No.	Base	Emitter	Collector	Measured in
Q1	2N2431	10.7	11.1	0	Receive *
Q2	2N3638	10.3	11.0	7.9	Receive *
Q3	2N3642	0	0	11.1	Receive *
Q4	2N3638	10.7	11.5	8.1	Transmit
Q5	2N2672	12.1	12.4	0	Transmit
Q6	2N2672	10.3	10.6	0	Receive
Q7	2N2672	11.6	11.9	0	Transmit
Q8	2N2672	11.0	11.3	0	Receive
Q9	2N2672	12.5	12.8	0	Transmit
Q10	2N2495	12.0	12.2	0	Receive
Q11	2N2672	11.7	12.0	0	Receive
Q12	2N3638	10.5	10.1	0.1	Receive
Q13	2N2672	12.8	12.6	0	Receive
Q14	2N2672	5.2	5.5	0	Receive
Q15	2N3564	1.43	0.81	5.8	Receive
Q16	2N3642	-1.02	0	12.1	Receive
Q17	2N3642	.94	0	.12	Receive
Q18	2N2926	.58	0	7.1	Receive
Q19	2N2672	11.6	10.5	0	Receive **
Q20	2N2869/2N301	10.4	10.7	.63	Receive
Q21	2N443	14.5	12.8	10.0 AC	Receive
Q22	2N443	14.5	12.8	10.0 AC	Receive
Q23	2N3567	13.6	13.1	13.6	Transmit

Measurements taken with 20,000 ohms-per-volt meter, no signal input, set powered from 117-volt AC.

* Volume control full clockwise.

** On 20 m band

TUBE VOLTAGES

Tube	PIN NUMBER							Cap
	1	2	3	6	7	8	9	
V1	6	0	6		405	170	0	
V2, V3	-22	-22	0	150	150	0	-	405

Notes:

1. 6 V. D. C. between filament pins 4 & 5 of V2 & V3. V1 filament pins 4, 5 and 6.
2. All measurements made with 120 V. A. C. input, microphone button depressed.

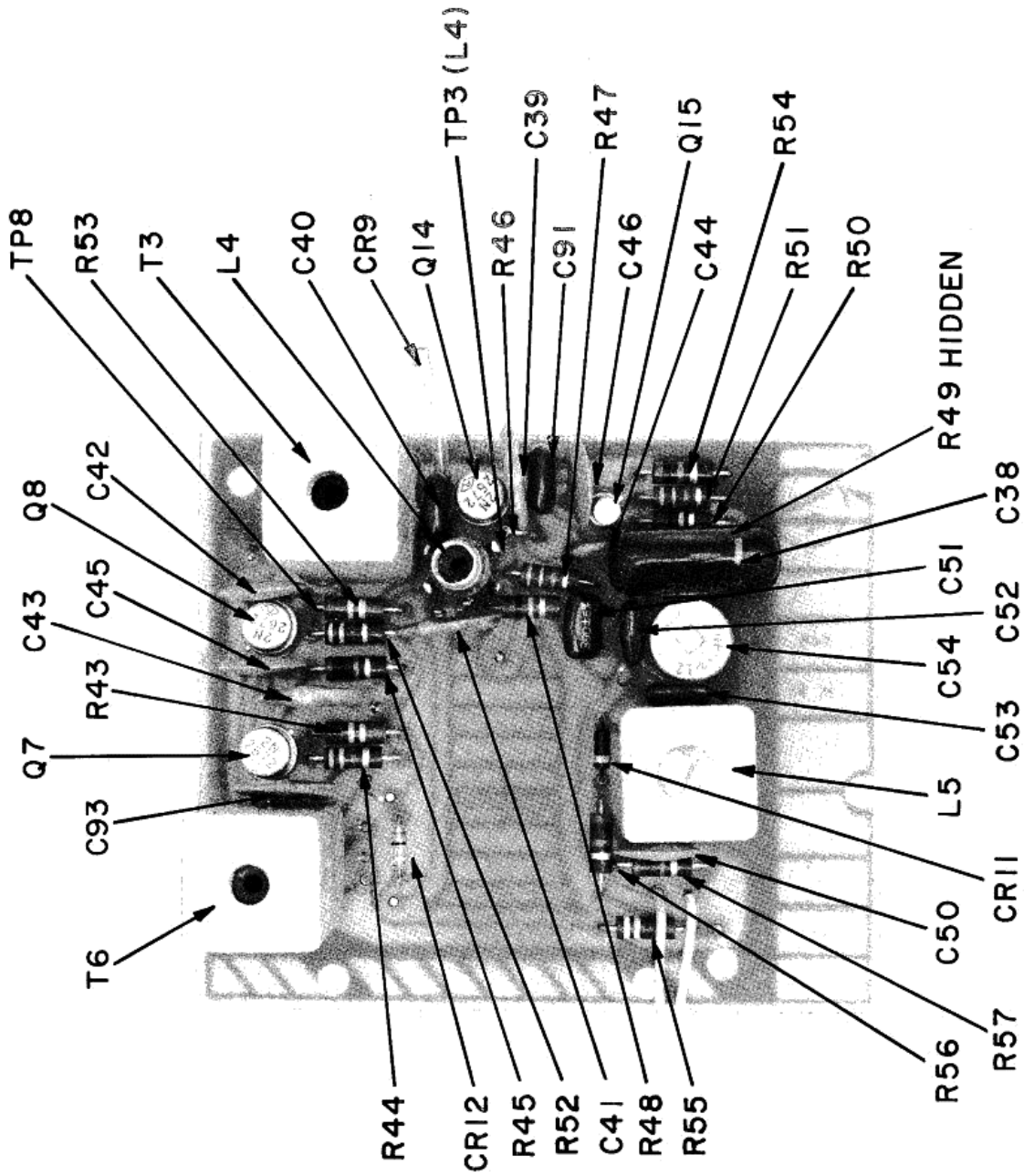

VFO BOARD

NOTE: ALL RADIOS MANUFACTURED AFTER
MAY 1, 1969 INCORPORATE THE FOLLOWING
DESIGN IMPROVEMENTS:

1. REVISED METERING CIRCUIT

REVISED SCHEMATIC:

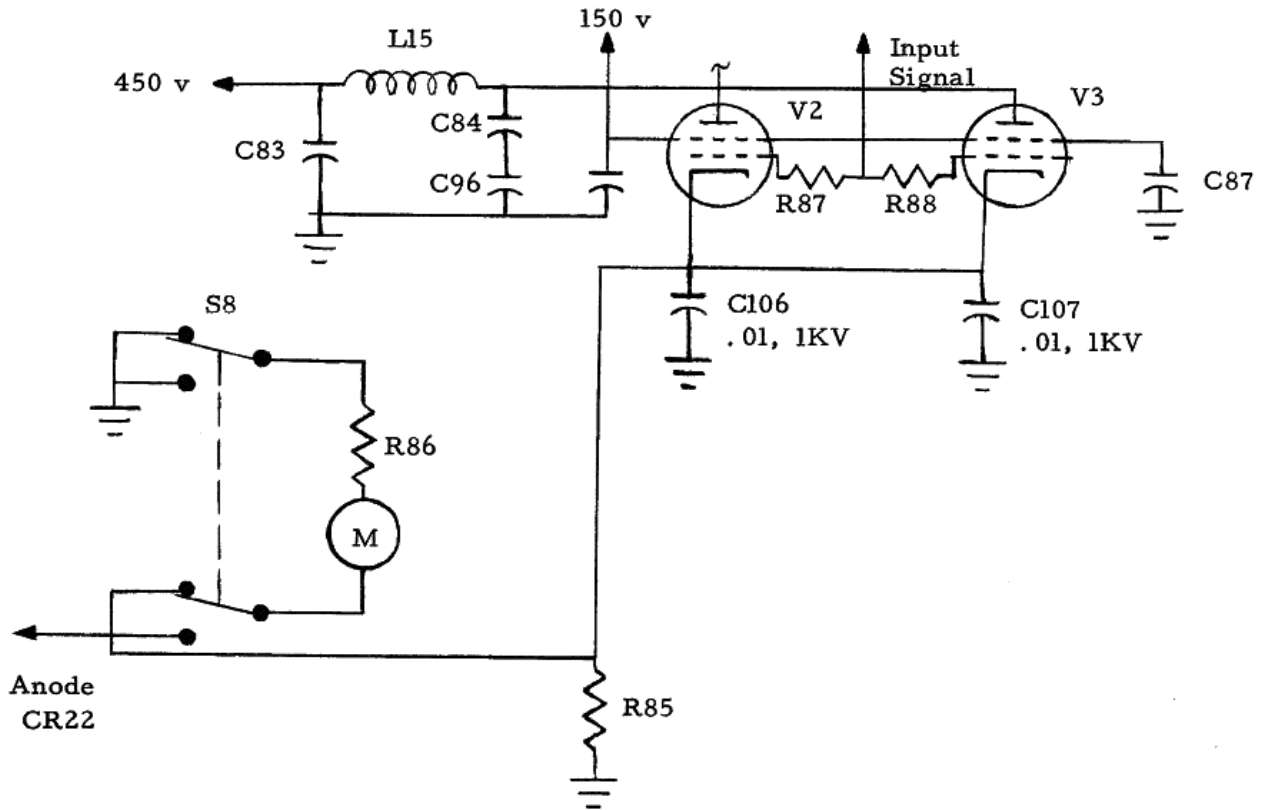

Component Changes Involved:

Was

Is

R85, Resistor, 1 ohm, 1/2 w, 4703-00016
C106, Capacitor, .01, 1KV, Ceramic,
1501-01028

C107, Capacitor, .01, 1KV, Ceramic,
1501-01028

2. AUDIO SIGNAL LEVEL INDICATOR ADDITION

REVISED SCHEMATIC:

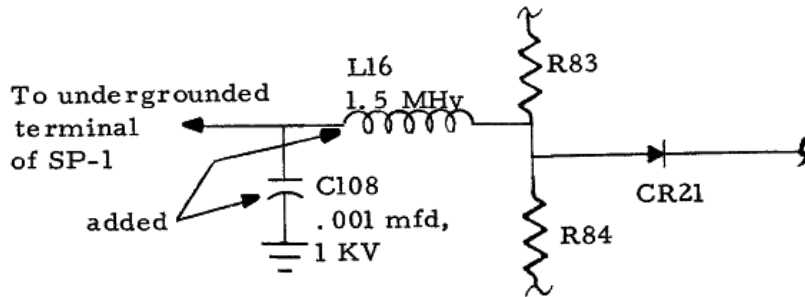

Component Changes Involved:

Was

Is

C108, Capacitor, .001 mfd, 1KV, 1501-01022
L16, Inductor, 1.5 MHy, 1801-00015

3. IMPROVE DOUBLER ACTION

REVISED SCHEMATIC:

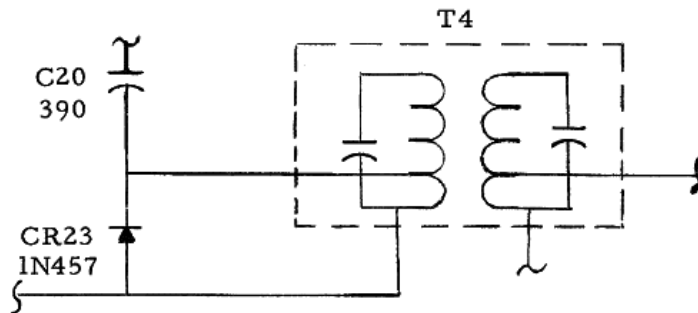

Was

CR8
R24

Is
Deleted

CR23, Diode, 1N457, 4801-00457
Deleted

4. ADDED DESPIKING DIODE

REVISED SCHEMATIC:

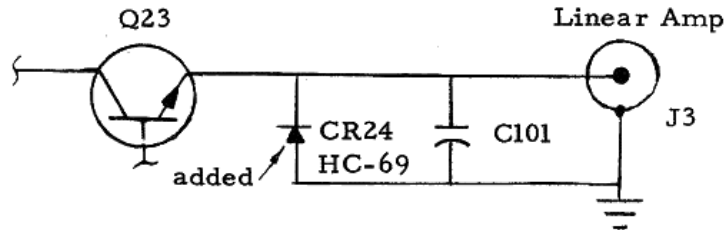

Component Changes Involved:

Was

Is

CR24, Diode, Type HC-69, 4801-00069

5. POWER SUPPLY IMPROVEMENTS

REVISED SCHEMATIC:

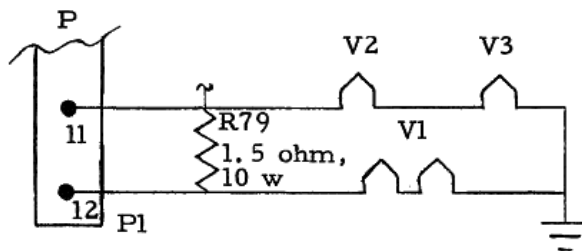

Component Changes Involved:

Was

Is

R79, Resistor, 1 ohm, 5 w
C72, Capacitor, 4 mfd, 150 v

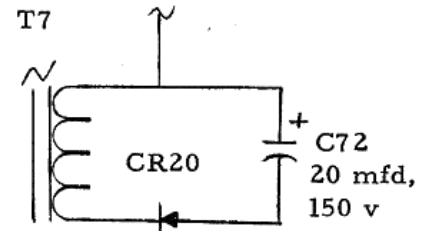

R79, Resistor, 1.5 ohm, 10 w, 4710-01011
C72, Capacitor, 20 mfd, 150 v, 1504-15009

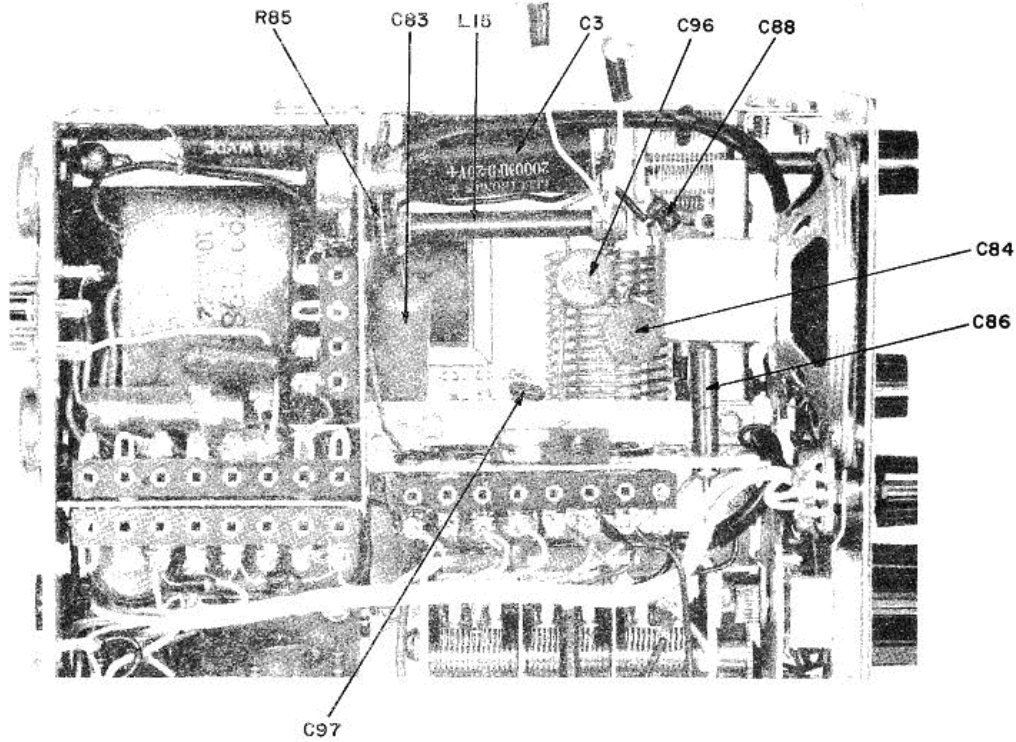

PA CAVITY WITH TUBES REMOVED

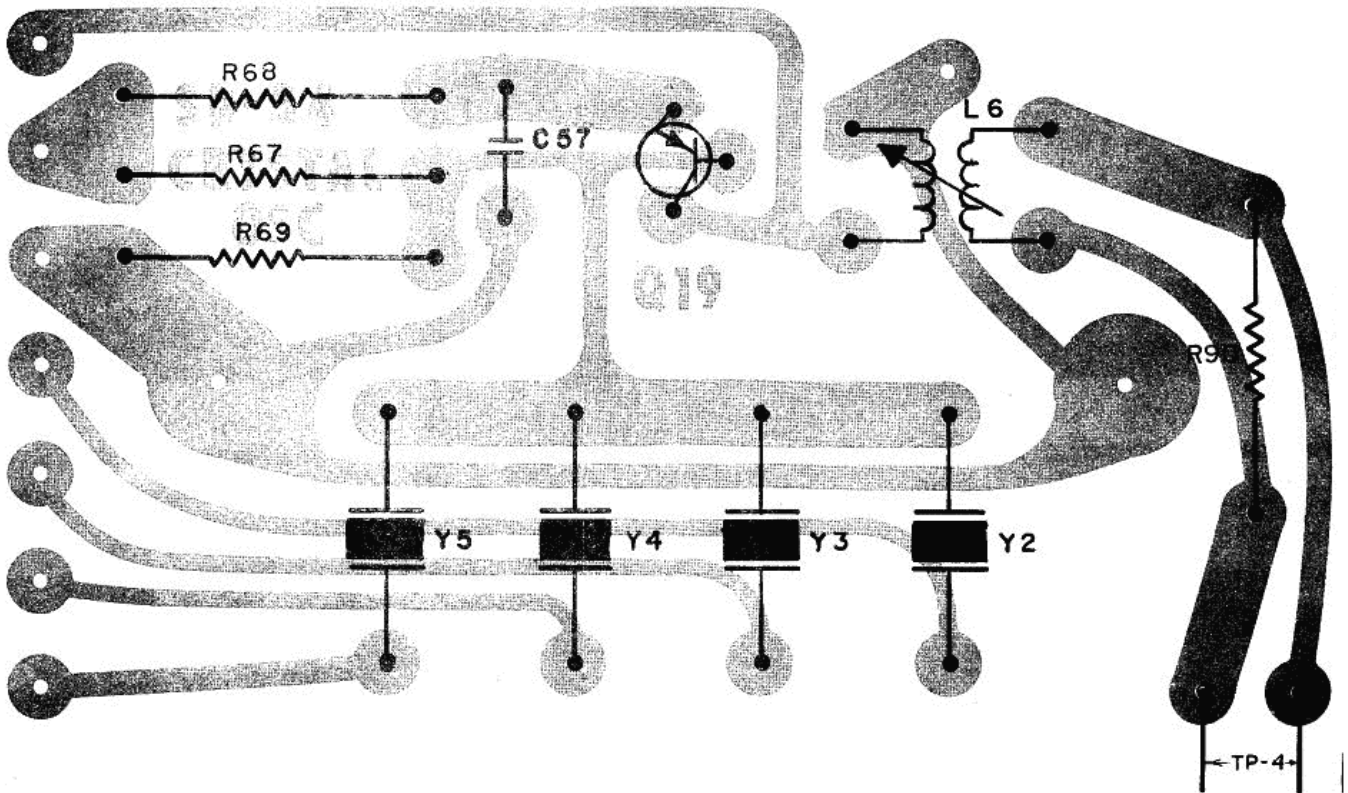

CRYSTAL OSCILLATOR BOARD BOTTOM

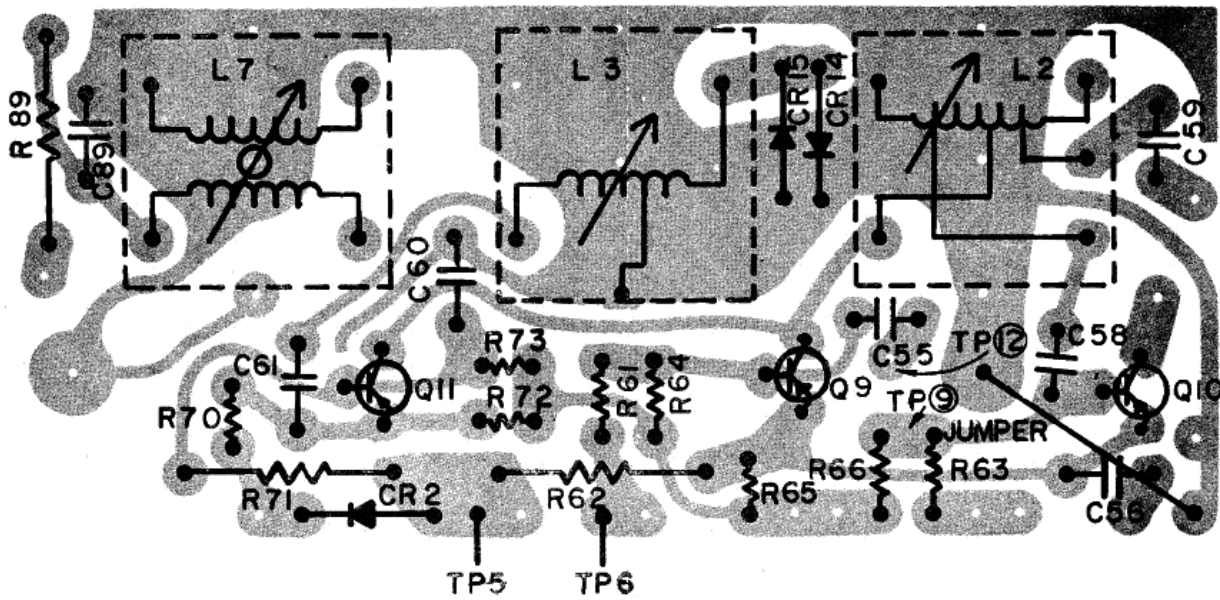
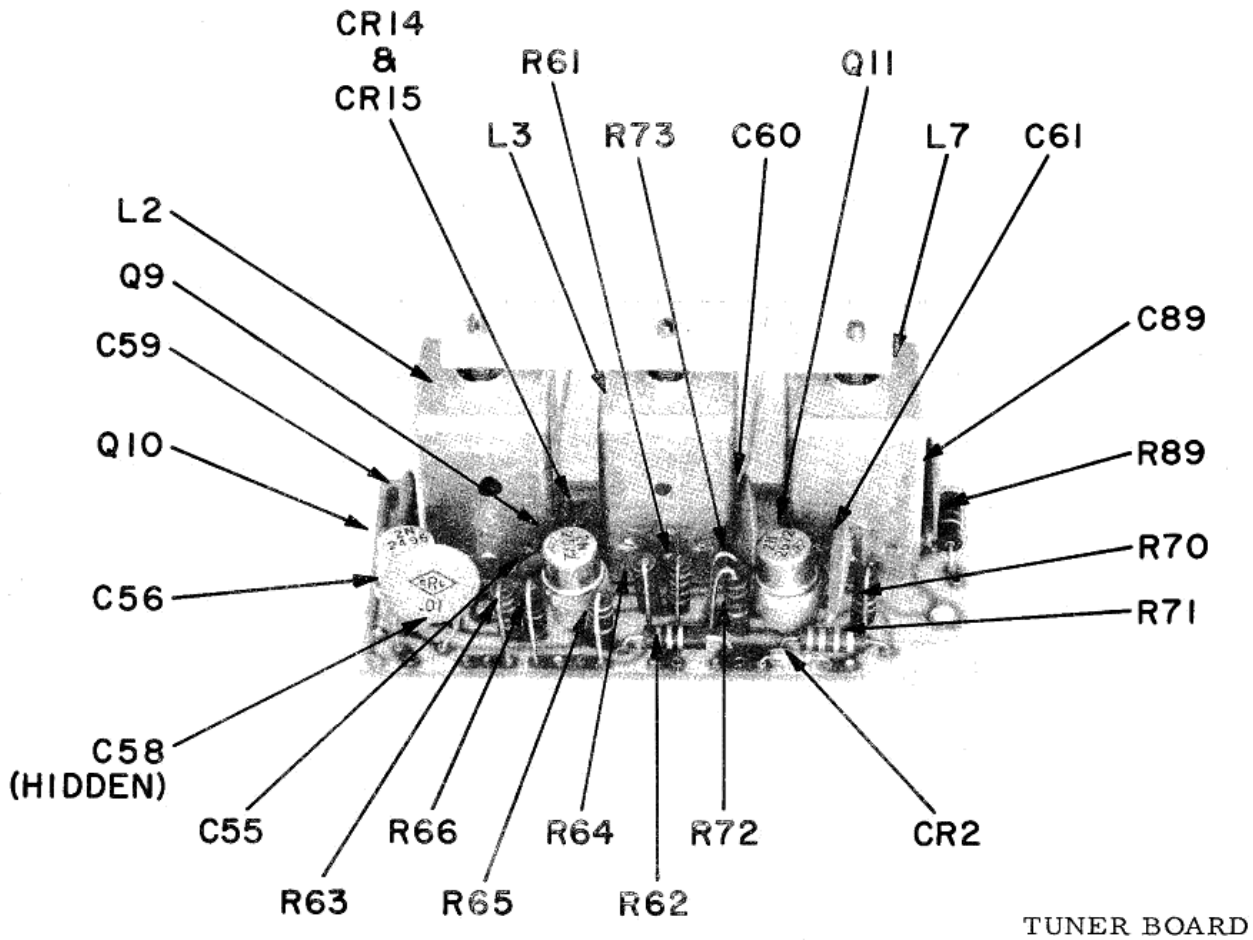

TUNER BOARD BOTTOM

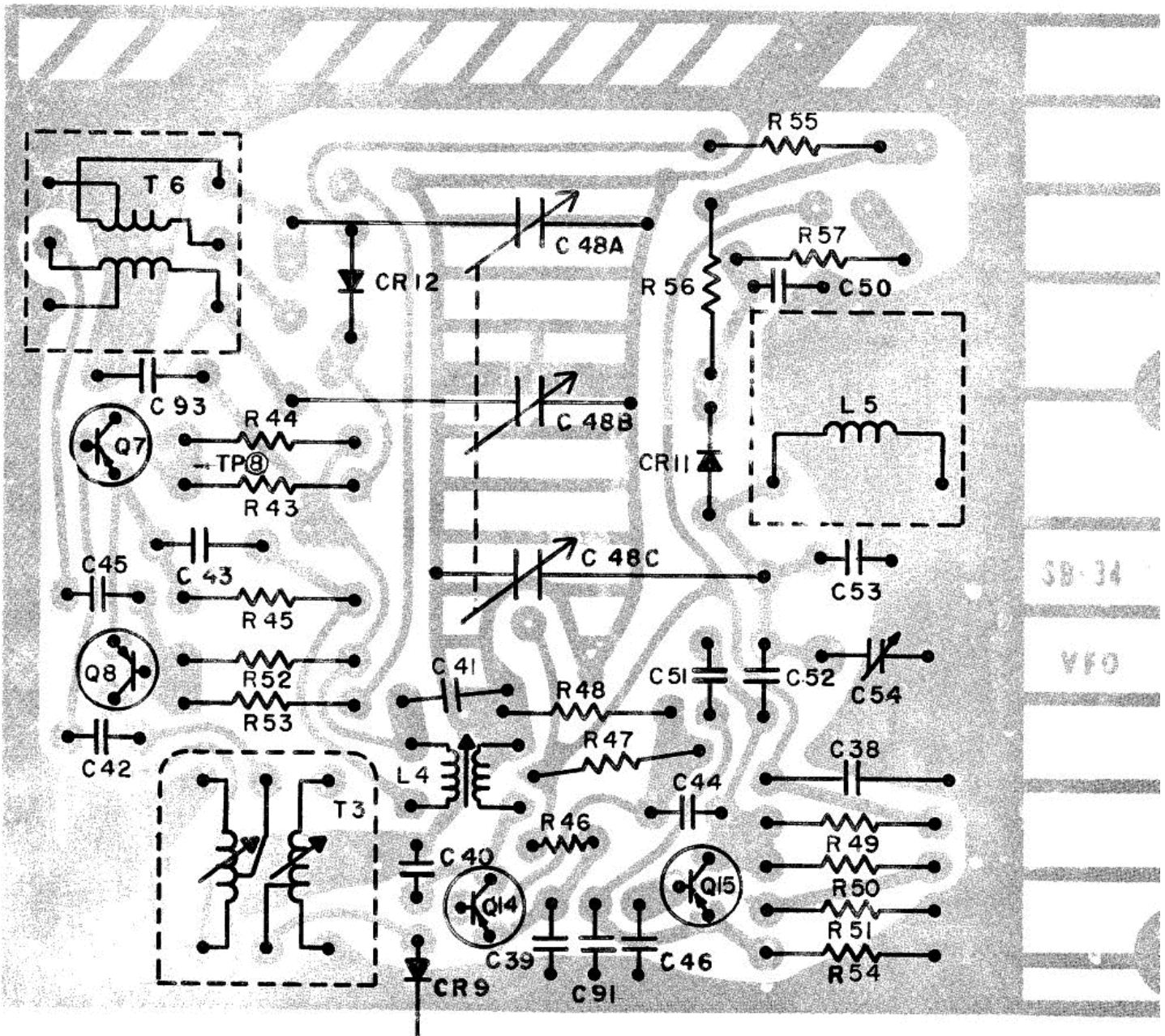

SB-34

VFO

VFO BOARD BOTTOM

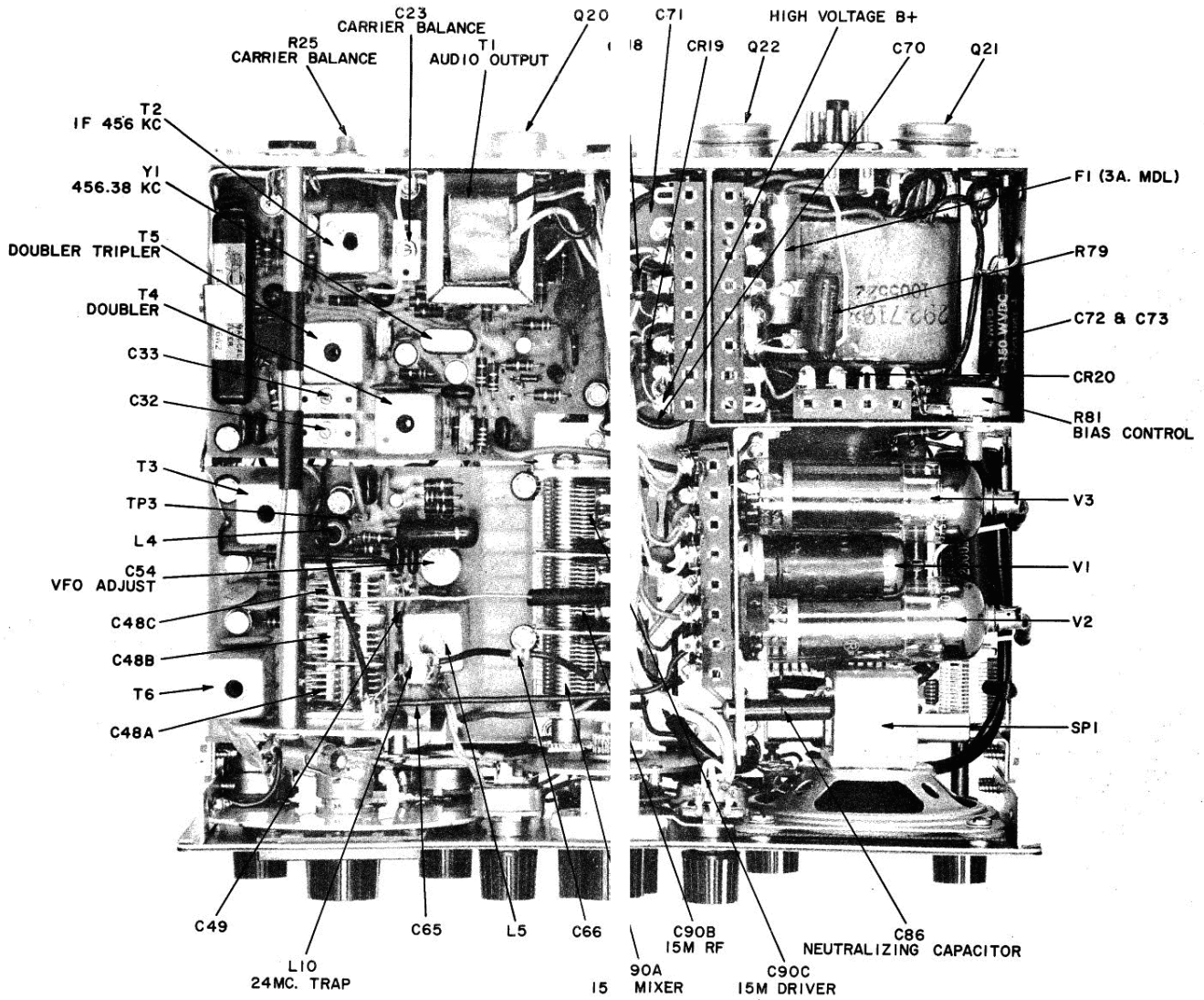

CHASSIS TOP VIEW

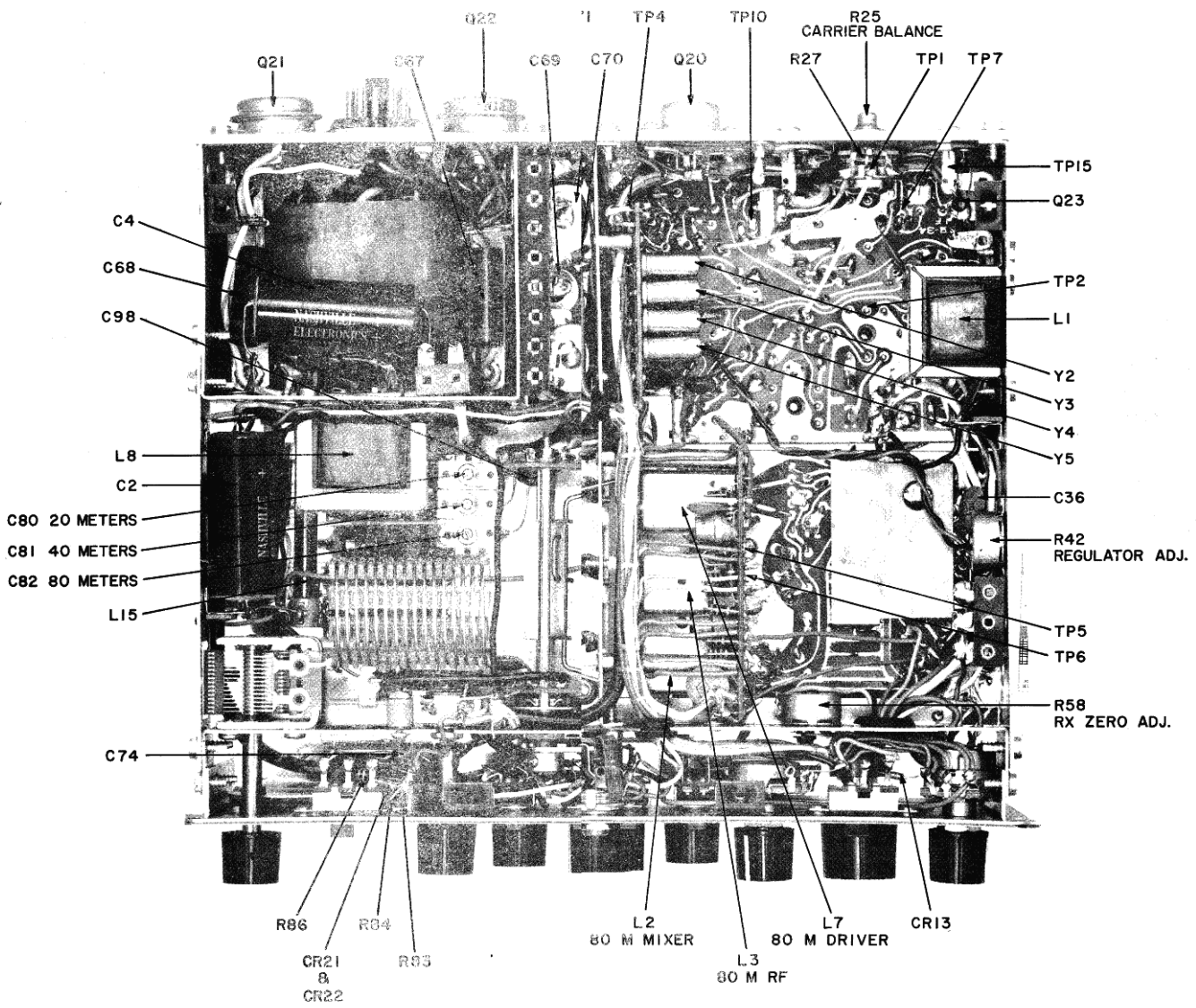

CHASSIS BOTTOM VIEW

Symbol	Stock No.	Description
C1,39,41,43, 93,99	235-7207P39	CAPACITORS
C2,3	235-7215P43	Ceramic, disc, .1mfd, 100V
C4	235-7353P84	Electrolytic, tubular, 2000mfd, 20V
C5,7,26,27,36, 42,45,46,50,56, 57,60,61,62,63, 85,87,89,95,101	235-7195P12	Electrolytic, tubular, 1000mfd, 25V
C6,10,15,16	235-7189P1	Ceramic, disc, .01mfd, 500V
C9,12,37,94	235-7215P1	Electrolytic, tubular, 3mfd, 12V
C11	235-7207P40	Ceramic, disc, .1mfd, 100V
C13,55	235-7188P15	Tantalum, 10mfd, 20V
C14,20,51	235-7207P8	Ceramic, disc, 100pfd, 600V
C17,29	235-7193P7	Mica, dipped, 390pfd, 500V
C18,21	235-7189P20	Mylar, dipped, .1mfd, 100V
C19,25	235-7193P7	Electrolytic, tubular, 250mfd, 12V
C22	235-7207P6	Mylar, dipped, 0.1mfd
C23,32,33	235-7263P1	Ceramic, disc, 56pfd, 600V
C24	235-7053P279	Variable, mica, compression
C28	235-7207P14	Mica, molded, 270pfd, 500V
C30,34,97,98	235-7053P104	Ceramic, disc, .001mfd, 600V
C31	235-7193P1	Mica, dipped, 150pfd, 500V
C33,40,91	235-7053P317	Mylar, dipped, 1000pfd, 100V
C38	235-7205P5	Mica, dipped, 560pfd, 500V
C44	235-7196P61	Mylar, dipped, .22mfd, 100V
C47	235-7200P2	Ceramic, disc, 15pfd, 500V
C48A,B,C	235-7185P1	Bakelite, tubular, 1.0pfd, 500V
C49	235-7196P9	Variable, 3-gang VFO
C52	235-7053P36	Ceramic, disc, 6.8pfd, 10%, NPO
C53	235-7053P44	Mica, dipped, 33pfd, 5%, 300V
C54	235-7260P1	Mica, dipped, 82pfd, 2%, 500V
C58	235-7207P28	Ceramic, variable, 5-12pfd
C59,74	235-7207P14	Ceramic, disc, .01mfd, 50V
C64	235-7195P60	Ceramic, disc, .002mfd, 1KV
C65,79	235-7196P63	Ceramic, disc, 33pfd, NPO
C66	235-7200P4	Bakelite, tubular, 4.7pfd, 100V
C67,68	235-7215P22	Electrolytic, tubular, 50mfd, 50V
C69	235-7215P33	Electrolytic, tubular, 100mfd, 50V
C70	235-7215P33	Electrolytic, tubular, 100mfd, 350V
C71	235-7215P39	Electrolytic, tubular, 300mfd, 150V
C72,73	235-7215P3	Electrolytic, tubular, 4mfd, 150V
C75	235-7064P5	Mica, dipped, 1100pfd
C76	235-7267P1	Mica, variable, compression, PA load
C77	235-7210P20	Mica "H" type, .0004mfd, 10%, 2500V
C78	235-7186P1	Variable, PA tune
C80-81-82	235-7274P1	Mica, variable, compression, 3-sec.

Symbol	Stock No.	Description
Q3,16,17	386-7185P1	2N3642
Q5,6,7,8,9,11, 13,14	386-7219P1	2N2672
Q10	386-7223P1	2N2495
Q15	386-7188P1	2N3564
Q18,23	386-7177P1	2N3567
Q19	386-7184P1	2N3638
Q20	386-7200P1	2N2869/2N301
Q21,22	386-7205P3	2N443 or AE443 Red
R1	240-7180P1	RESISTORS
R25	240-7178P1	All fixed resistors are 10% carbon, 1/2 watt unless otherwise noted on schematic.
R41	240-7181P1	Microphone Gain Control, 10K Ω
R42	240-7196P1	Carrier balance, 200 Ω
R42	240-7206P1	Volume Control, 5000 Ω w/switch S5
R58	240-7179P1	Regulator adjust, MW, 50 Ω , 2W
R59	240-7179P1	Receiver zero adjust, MW, 1K Ω , 2W
R60	240-7179P1	Pitch control, 1000 Ω
R79	280-1106P1	Dial correct, 1000 Ω
R81	240-7221P1	Fixed MW, 1 Ω , 5W
		Bias control, 10K Ω
S1	228-7280P1	SWITCHES
S2	228-7280P1	Tune-Operate, DPDT slide
S3	228-7278P1	USB-LSB, DPDT slide
S4	228-7277P1	Pitch OFF-ON, SPDT slide, .5-amp, 125V
S6	228-7279P1	Calibrate, SPST slide, 1-amp, 125V
S7,A,B,C	228-7194P1	Part of R41
S8	228-7280P1	Transmitter, SPST slide, 10-amp, 125V
SP1	352-7177P1	Rotary Switch Assembly
		Meter, DPDT slide
		SPEAKER, 3.2 Ω
		TRANSFORMERS
T1	292-7199P1	Audio output
T2	375-7222P1	IF, 456Kc (red dot)
T3	375-7222P4	IF, 2281.9Kc
T4	375-7222P2	Doubler (green dot)
T5	375-7222P3	Doubler/Tripler (yellow dot)
T6	375-7222P5	IF, 3350Kc
T7	292-7198P1	Power

Symbol	Stock No.	Description
C83	235-7212P14	Paper, tubular, .1mfd, 600V
C84, 96	235-7207P25	Ceramic, disc, .0047mfd, 3KV
C86	235-7259P1	Ceramic, neutralizing
C88	235-7053P0	Mica, dipped, 2pfd, 500V
C90, A, B, C	235-7184P1	Variable, 3-gang
C92	235-7200P6	Bakelite, tubular, 1.5pfd, 100V
C102, 105	235-7193P57	Mylar, dipped, .1mfd, 100V
C103	235-7193P54	Mylar, dipped, .02mfd, 100V
C104	235-7193P57	Mylar, dipped, .1mfd, 100V
		DIODES
CR1, 2, 4, 5, 6, 7, 8, 21, 22	322-7186P3	Germanium, S262
CR9	322-7186P6	Germanium, 1N87A
CR10	322-7175P5	Zener, 7.0V, 5mA
CR11	386-7178P1	Transistor 2N3565
CR12, 13	322-7186P2	Germanium, 1N270
CR14, 15	322-7184P2	Silicon, planar, HE9010
CR17, 18, 19, 20	322-7180P1	Silicon, 1N2071
F1	226-1009P11	FUSE, 3amp, MDL
L-1	277-1013P1	LAMP, 28V, .17A bayonet
		SOCKETS
J-1	276-7195P1	Microphone
J2, 4	282-7185P1	Vox & Calibrator, 7-pin min. tube
J3, 5	276-7250P1	Antenna & Linear amp.
		COILS
L1	292-7200P1	Audio choke
L2	375-7223P1	Tuner (black dot)
L3	375-7223P2	Tuner (red dot)
L4	375-7260P1	VFO buffer
L5	375-7226P1	VFO
L6	375-7224P1	Crystal oscillator
L7	375-7223P3	Tuner (orange dot)
L8	292-7184P1	Filter
L9	375-7221P1	PA tank
L10	375-7183P1	23 mc trap
L11, 12	375-7274P1	RF choke, 1mh
L13, 14	375-7178P1	RF choke, 1mh
L15	375-7220P1	RF choke
M	245-7181P1	METER
P1	276-7269P1	PLUG, power
		TRANSISTORS
Q1	386-7224P1	2N2431
Q2, 4, 12	386-7184P1	2N3638

Symbol	Stock No.	Description
V1	290-7247P2	TUBES
V2, 3	290-7215P1	12DQ7
		6GB5
		CRYSTALS
Y1	394-7189P1	456.38Kc
Y2	394-7185P1	7200Kc (80 meter)
Y3	394-7186P1	10475Kc (40 meter)
Y4	394-7187P1	17525Kc (20 meter)
Y5	394-7188P1	24625Kc (15 meter)
		MISCELLANEOUS
	7267-5005G1	Cabinet, complete w/handle
	7267-7012P1	Cable, DC, W-70
	7267-7013P1	Cable, AC, W-71
	7267-1065P1	Clamp, Mech. Filter
	7267-1045P1	Dial, Frequency
	7267-1027P1	Dial, Bezel
	7267-1028P1	Dial, Window
	7267-1047G1	Geneva Wheel assembly
	7251-1021G1	Geneva Plate assembly
	7267-1042P1	Grill, speaker
	231-7221G1	Handle, w/mounting clips
	231-7192P4	Knob, small round
	231-7196P2	Knob, large round, tuning
	231-7191P2	Knob, pointer, bandswitch
	369-7174P1	Mechanical Filter
	7267-1026P1	Panel, Front overlay
	7267-1035P1	Shaft, extension for C76
	7267-1063P1	Shield, top
	7267-1062P1	Shield, bottom
	7267-1064P1	Shield, VFO board
	386-7193P1	Socket, transistor, small
	386-7194P1	Socket, transistor, power
	282-7196P1	Socket, tube V-1
	282-7194P2	Socket, tube V-2-3
		Tuner Slug Assembly Parts
	297-7182P1	Ferrite slug (L-2-3-7)
	7251-1062P2	Slug connecting rod, nylon
	7267-1038P1	Yoke, wire
	7251-1024P1	Yoke Keeper, wire
	7251-1026P1	Yoke attachment bracket
	7267-1041P1	Vernier Drive, dial, ball
	7267-5016G2	I. F. Printed Circuit Board (less mechanical Filter)

WARRANTY REPAIR

If you should wish to return equipment directly to SBE, 220 Airport Boulevard, Watsonville, California, 95076, under this Warranty, you should notify SBE giving full particulars including:

1. Model number, description and serial number of equipment.
2. Date of purchase of equipment.
3. Nature of trouble.
4. Cause of trouble if known.
5. Name of distributor from whom the equipment was purchased.

Upon receipt of such notice, SBE will advise you respecting the return.

Failure to secure our advice prior to forwarding the equipment, or failure to provide full particulars may cause unnecessary delay in processing of returned merchandise.

OUT-OF-WARRANTY REPAIR SERVICE BULLETIN MODIFICATION, ALIGNMENT, ETC.

For information service of this type write SBE, 220 Airport Boulevard, Watsonville, California, 95076, prior to shipping the equipment. If you wish to return your equipment for repairs, etc., be sure to include the following information attached to the equipment inside the packing carton:

1. Complete instructions detailing work to be performed.
2. Your return address.
3. Method of shipment by which the equipment should be returned.

NOTE: Return shipment will be COD for repair charges, unless prepaid, or shipped to SBE Distributors.

4. Special instructions

HOW TO ORDER REPLACEMENT PARTS

When ordering replacement parts, you should direct your order to an SBE Distributor or SBE, Replacement Parts Department, 220 Airport Boulevard, Watsonville, California, 95076.

Please furnish the following information:

1. Quantity required.
2. SBE part number and description.
3. Item or symbol number obtained from parts list or schematic.
4. SBE model number, description and serial number of principal equipment.
5. Unit subassembly number (if applicable).