

# **hy-range III** BY **hy-gain**

**23-CHANNEL  
SOLID STATE 5-WATT MOBILE  
CITIZENS TWO-WAY RADIO**



## **MODEL 672B**

**INSTRUCTION MANUAL**

## General Description

Your Hy-Range III is a full 23-channel transceiver designed and licensed for Class D Citizen Band operation as designated by the Federal Communications Commission (F. C. C.).

The Hy-Range III is a compact completely solid state unit providing high reliability and low power consumption. This transceiver utilizes a highly advanced, unique system of frequency synthesization enabling immediate operation on all 23 channels without the need of additional crystals or adjustments. This unit also features a fine tune control allowing you to make adjustments for stations which may operate slightly off frequency. Additional features include a NB (Noise Blanker)/ANL (Automatic Noise Limiter) switch which reduces undesirable noises and a public address system which utilizes the microphone and the audio stages within the transceiver.

The Hy-Range III transceiver is designed to operate from 11.5 to 14.5 volts DC. To obtain the best results from your transceiver, it is suggested that you read all the instructions contained in this manual.

## FRONT PANEL

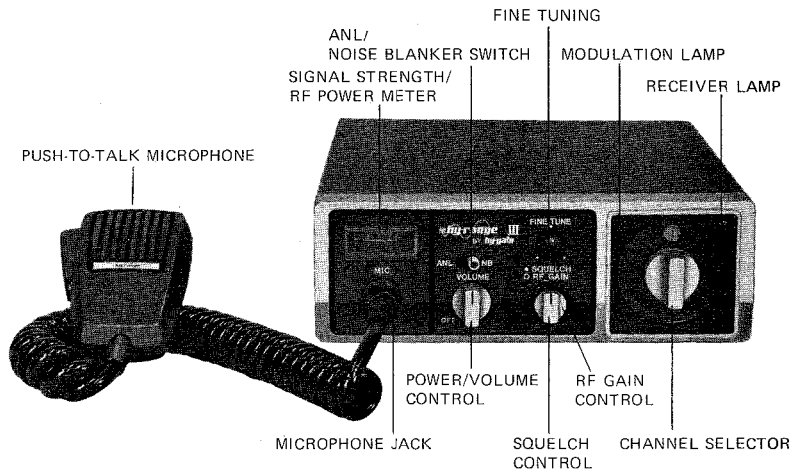

FIGURE 1.

## REAR PANEL

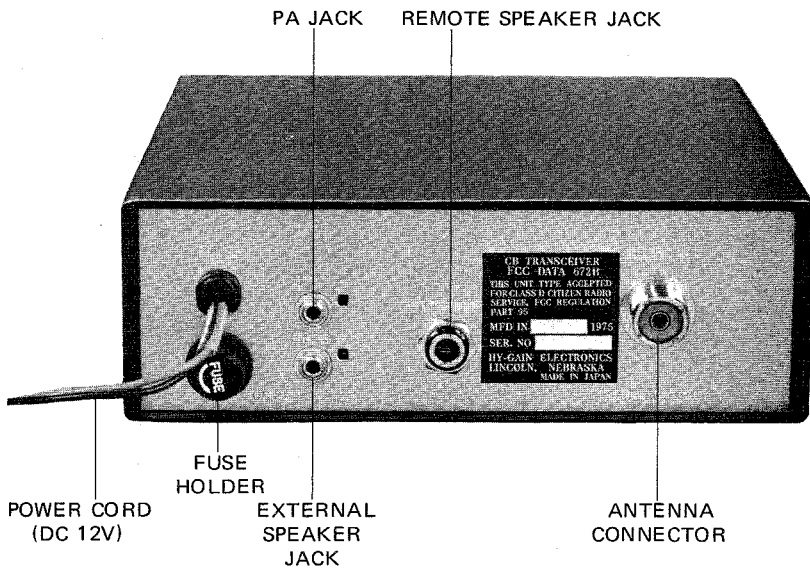

FIGURE 2.

## Specifications

### Citizens Two-way Receiver Section

Circuit type . . . . .	dual conversion superheterodyne with RF stage and 455 kHz ceramic filter
Frequency . . . . .	23 crystal-controlled channels in the 27 MHz Citizens Band
Sensitivity . . . . .	0.7 $\mu$ V for 10 dB (S + N)/N ratio
IF frequency . . . . .	1st IF: 11.275 MHz 2nd IF: 455 kHz
Audio output . . . . .	3 watts maximum into external speaker jack
Receiving current drain	about 300 mA on Standby (no signal)

### CB Transmitter Section

Frequency . . . . .	23 crystal-controlled channels in 27 MHz Citizens Band.
Power input . . . . .	5 watts
RF Power output . . . . .	4 watts
Emission . . . . .	8A3
Spurious response rejection . . .	all harmonic and spurious suppression better than Federal Communications Commission and Department of Com- munications (DOC) requirements.
Modulation . . . . .	AM, 90% typical
Range boost . . . . .	yields high average modulation at average voice levels
Transmitting current drain . . .	less than 1.2 amp
Antenna . . . . .	nominal 50 ohms impedance
Power source . . . . .	12 DVC nominal

**Licensing your  
Citizens Two-way  
Radio in the United  
States**

NOTICE: It is illegal to transmit with this transceiver until you obtain your citizens two-way radio Class D license. You are also required to read and understand Part 95 of the Federal Communications Commission rules and regulations before operation of this unit. License application Form 505 is packed with your transceiver and Part 95 of the regulations may be available from your dealer; if not, you may obtain copies from the Superintendent of Documents, Government Printing Office, Washington, D. C. 20402.

It is also prohibited by the F.C.C. to adjust the transmitter circuit of this unit unless you hold a current First or Second Class Radio-telephone License.

We recommend that you refer all servicing of any Hy-Gain products to your nearest Hy-Gain warranty service center or consult your Hy-Gain dealer or distributor for the service center location nearest you. Do not tamper with any internal adjustments or settings - - such tampering can adversely affect the performance of your transceiver or may, in fact, cause your unit to operate beyond the limitations set forth for Class D citizens two-way transceivers by the F. C. C.

**Installation**

General Considerations

Before installing the transceiver in a car, truck, boat, etc., be sure to choose a location which is convenient to the operating controls and will not interfere with the normal functions of the driver. The transceiver may be mounted to the underside of the instrument panel or dashboard of a car, truck, boat, etc., by means of the special bracket supplied with your transceiver.

Mounting Bracket

The mounting bracket may be used for base type or gimble type overhead mounting. Secure the bracket to the underside of the instrument panel by using at least four screws or nuts, washers, bolts combinations or self-tapping screws.

DC Power Connections

The Hy-Range III may be operated from a nominal 12 VDC battery source on negative or positive ground systems.

NOTE: Before making any power connections, determine whether the vehicle has a negative or positive ground electrical system, then make the following connections:

Connect the red lead to the vehicle "+" (positive) side of the electrical system, and the black lead to the vehicle "-" (negative) side of the electrical system.

In the case of negative ground vehicles, the red lead should be connected to the accessory post on the ignition switch, the voltage regulator side of the ammeter or the accessory side of the fuse block. The black lead should be connected to the metal firewall or any other point that is connected to the vehicle chassis (ground).

In the case of positive ground vehicles, the black lead should be connected to the accessory post on the ignition switch, the voltage regulator side of the ammeter or the accessory side of the fuse block. The red lead should be connected to the metal firewall or any other point that is connected to the vehicle chassis (ground).

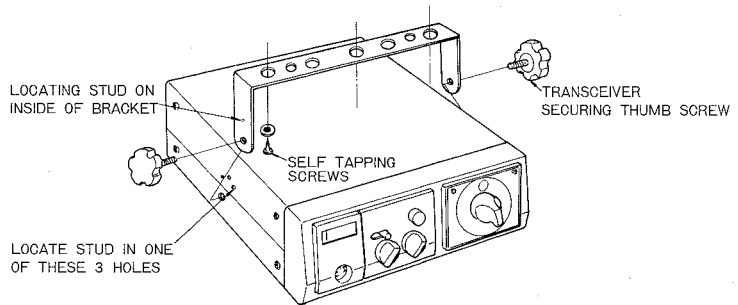

**FIGURE 3 Transceiver Mounting**

#### Antenna Connection

The antenna should be connected to the transceiver by means of coaxial cable. Either RG-58/u or RG-8/u coaxial cable may be used. The cable should be terminated with a PL-259 coaxial connector. Screw the PL-259 coaxial connector onto the antenna jack.

#### Caution :

Do not try to transmit without an antenna connected to the transceiver.

#### Remote Speaker Jack

This will be used to control the built-in speaker when operating the transceiver with the optional telephone handset connected.

#### Public Address (PA) Speaker Jack

This jack is used for connection of an 8-ohm PA speaker for PA operation.

## Noise Suppression

### External Speaker (EXT. SP.) Jack

This jack can be used with any 8-ohm earphone or speaker. Inserting a 3.5 mm plug into the jack automatically silences the internal speaker.

### Tune-up

In most mobile installations, ignition noise is a problem.

Before beginning any special noise suppression steps, be sure that the vehicle is well-tuned. Clean and tighten all electrical connections, including alternator, battery, regulator and coil connections. Perform the following maintenance steps as necessary. Solder any crimped spark plug or distributor leads; clean and regap or replace spark plugs and ignition points; and check and clean alternator rings or generator brushes. Retune the engine at the manufacturer's recommended intervals.

### Corrective Steps

Usually several sources of noise are present in any vehicle, with the strongest covering the others. In order to find and eliminate the maximum number of noise sources, you will have to start with the strong sources and then work back. To be sure the noise you hear comes from your vehicle and not outside it, drive to a relatively quiet location (free of man-made electrical interference such as noisy power lines, industrial noise or other vehicles). Test for noise with a weak signal on the channel and the engine off. Then start the engine. Ignition noise will probably be present at all engine speeds. If it is severe, it may make a normally readable signal unreadable. To reduce ignition noise, install resistor-type spark plugs if these are not already installed. If non-resistance ignition wiring is used, install a 10 k-ohm suppressor resistor at each spark plug tower of the distributor. Install a coaxial capacitor at the ignition coil primary as close to the coil primary as possible. This capacitor can be purchased from an electronics parts company or an automotive electrical service company.

A "whining" noise which varies with engine speed and continues with the ignition turned off and the vehicle coasting in gear is characteristic of the alternator. Check and clean it and install an alternator filter (same sources as above).

An irregular, clicking sound which disappears at a slow idle characterizes the voltage regulator. Install a 4-ohm carbon resistor as close to the field terminal of the regulator as possible, then a .002  $\mu$ F capacitor in series with and as close to the resistor as possible. Connect the capacitor to ground. See the detail drawings of Figure 4.

Irregular popping noises which vary with road surfaces indicate static discharge at any of several locations in the vehicle. Tighten loose nuts and bolts and bond large areas such as the fenders, exhaust pipe, firewall, etc. to the frame with lengths of heavy wire braid.

More Help

Figure 4 illustrates these noise suppression steps. Additional information is available in the Radio Amateur's Handbook published by the ARRL.

The Hy-Gain 672B transceiver does contain a noise blanker for reduction of impulse noise. However, to get the best reception, noise suppression steps should be taken at the source of the noise.



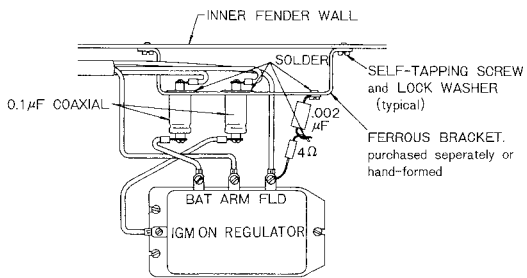
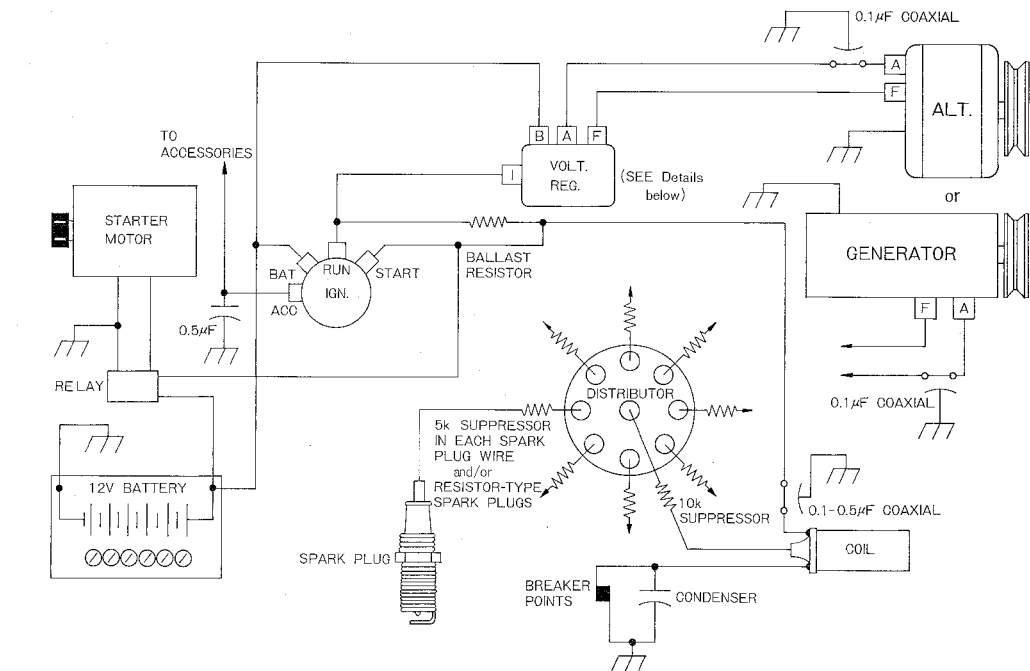

— FOR CARS EQUIPPED WITH —  
ALTERNATOR

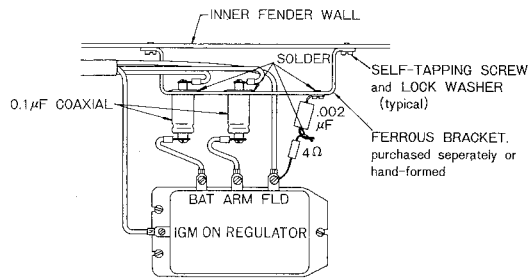

— FOR CARS EQUIPPED WITH —  
GENERATOR

FIGURE 4 Noise Suppression Diagram

## Use of Controls

### Power/Volume switch.

To turn the power on, rotate the knob clockwise. Further rotation will increase the sound output from the speaker. To turn the power off, rotate the knob counterclockwise until the click is heard indicating the power is turned off from the power supply.

### Squelch Control

This control is used to eliminate annoying background noise at no signal. To adjust the squelch control properly, first turn the knob counterclockwise until background noise is heard. Then, rotate the knob slowly clockwise until the background noise just disappears. At this point, the receiver will be relatively quiet under no signal conditions, but an incoming signal will overcome the squelch action and be heard. Since this control is variable, it can be used to provide varying degrees of sensitivity to incoming signals. As the control is advanced from the extreme counterclockwise position the squelch action is progressively increased and stronger signals are needed to overcome it. To receive extremely weak signals or to disable the squelch circuit, simply turn the control fully counterclockwise.

### RF Gain Control.

This controls RF gain when receiving. To increase RF gain (reception sensitivity) turn the knob clockwise and to decrease turn counterclockwise.

### Channel Selector.

Continuously rotating switch selects any one of 23 channels for transmit and receive operation. The PA position will be used when the transceiver is used as a PA (public address) amplifier.

### Fine Tuning.

This will be used for clear reception of stations that are slightly off frequency. Rotate the knob for clearer reception.

### Modulation Lamp.

This lights up when the push-to-talk button on the microphone is pressed and flickers according to your voice while transmitting.

### Receiver Lamp.

This lights up when the transceiver is in the receive mode.

### Mic Jack.

Connect the push-to-talk microphone or the optional telephone handset.

### Signal Strength/RF Power Meter.

During reception, the built-in meter provides a relative indication of signal strength in "S" units on the upper scale and thus offers basis for comparison between one incoming signal and another. During transmit, this will provide an indication of antenna RF power on the lower scale. As you speak, the pointer should "flicker" slightly, indicating that you are modulating the RF carrier.

### ANL/NB (noise blanker) Switch.

The noise blanker will suppress much of the pulse-type interference, "ignition noise," that is often a problem. The depth of the blanking and its relative effectiveness are determined by the signal strength of the stations around you. This is known as the "threshold level" If any station is putting out an S-9 or greater signal on any channel, the effectiveness of the blanker will be at least partially blocked. As far as when to use the blanker is concerned, generally, it is left on all the time when you are operating mobile. But when operating as a base station, you may also find it very helpful.

Don't confuse the action of a noise blanker with a noise limiter. Noise limiters only clip off the peaks of the noise so that it is not as annoying. This is helpful, but a noise blanker is much more effective. It actually turns the receiver off momentarily so that no noise at all is heard.

When this switch is placed in the ANL position, only atmospheric -type noises are reduced. But when it is placed in NB position both the ANL and NB circuits are functioning.

## Operating Procedures

### CB Transmitter Operation

**IMPORTANT:** Do not try to transmit without a CB antenna connected to the antenna connector on the rear panel.

1. Connect the microphone to the microphone socket.
2. Turn channel selector to a desired channel.
3. Depress the push-to-talk button on the microphone. Hold the microphone 4 to 6 inches from the mouth. Speak at a normal level. During periods of transmission, the receiver is silenced and reception is therefore impossible. In the same way, your signal can not be heard by another station when he is transmitting. Each must take turns.
4. To receive, simply release the microphone push-to-talk button.

### Public Address Operation

Special provision has been made for Public Address operation, utilizing the microphone and audio stages in the unit.

1. Connect a external PA speaker to the PA jack on the rear panel.
2. Set the CB channel selector in the "PA" position.
3. Press the push-to-talk button on the microphone and talk into the mic. Your voice will be heard from the external speaker which may be mounted on the exterior of a car, boat, or building.

NOTE: The volume control on the transceiver can also control the PA speaker output during PA operation.

# SCHEMATIC DIAGRAM OF MODEL 672B

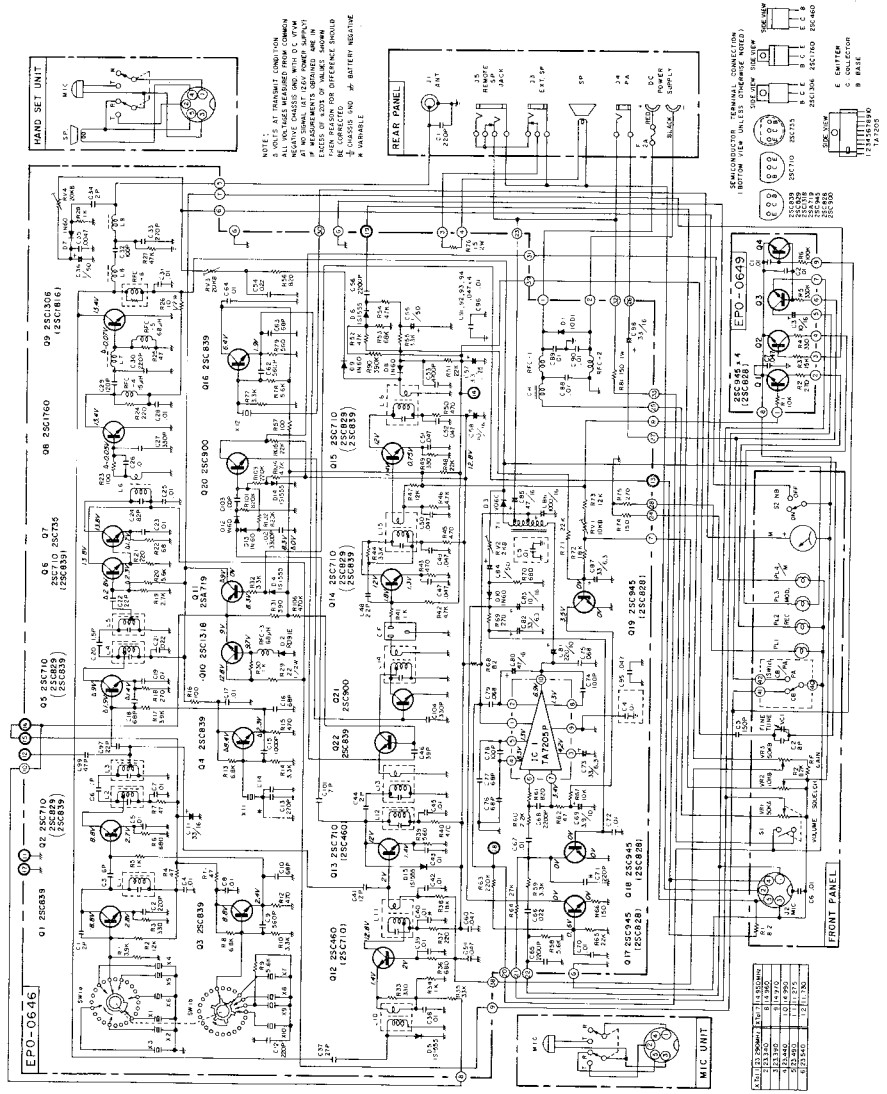

NOTE:  
 1. WIRE AT TRANSMIT CONDITION.  
 2. ALL VOLTAGES MEASURED FROM COMMON AT NO SIGNAL (1/2 LINE POWER SUPPLY).  
 3. RESISTANCE VALUES IN OHMS UNLESS INDICATED OTHERWISE.  
 4. CAPACITANCE IN MICRO FARADS UNLESS OTHERWISE INDICATED.  
 5. BATTERY POSITIVE TO BATTERY NEGATIVE.

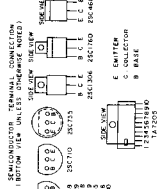

VAL.	RES.	VAL.	RES.	VAL.	RES.
100	1000	1000	10000	10000	100000
1000	10000	10000	100000	100000	1000000
10000	100000	100000	1000000	1000000	10000000
100000	1000000	1000000	10000000	10000000	100000000
1000000	10000000	10000000	100000000	100000000	1000000000
10000000	100000000	100000000	1000000000	1000000000	10000000000
100000000	1000000000	1000000000	10000000000	10000000000	100000000000
1000000000	10000000000	10000000000	100000000000	100000000000	1000000000000
10000000000	100000000000	100000000000	1000000000000	1000000000000	10000000000000
100000000000	1000000000000	1000000000000	10000000000000	10000000000000	100000000000000
1000000000000	10000000000000	10000000000000	100000000000000	100000000000000	1000000000000000
10000000000000	100000000000000	100000000000000	1000000000000000	1000000000000000	10000000000000000
100000000000000	1000000000000000	1000000000000000	10000000000000000	10000000000000000	100000000000000000
1000000000000000	10000000000000000	10000000000000000	100000000000000000	100000000000000000	1000000000000000000

## SERVICE INFORMATION

### Warranty Repair

If your receiver should need servicing under the warranty, contact your Hy-Gain dealer for the Hy-Gain Service Center nearest you. Please contact the Service Center before shipping your transceiver to him. All equipment returned for warranty repair must be accompanied by your sales slip or invoice, or a copy of either.

Units that have been modified cannot be accepted for repair.

### How to Ship Returns

Include all information requested by the Service Center. Then pack the unit as follows:

Check the unit to see that all parts and screws are in place. Then wrap it in heavy paper or put it in a plastic bag. If the original carton is not available, place the unit in a strong carton that is at least six inches bigger in all three dimensions than the unit. Fill the carton equally around the unit with resilient packing material (shredded paper, excelsior, etc.). Seal it with gummed paper tape, tie it with a strong cord, and ship it by prepaid express, United Parcel Service, or insured parcel post to the Hy-Gain Service Center.

It is very important that the shipment be well-packed and fully insured. Damage claims must be settled between you and the carrier and this can delay repair and return of the unit to you.

### Purchase of Parts

Parts can be purchased from the factory Customer Service Department. All parts orders must be prepaid or COD. When ordering, please supply the following information:

1. model number of the unit
2. serial number of the unit
3. description of the part
4. part number. (if available)

Address your letter to:

Hy-Gain Warranty  
Service Department  
4900 Superior Avenue  
Lincoln, Nebraska 68505  
Attn: National Service Manager

## 90-DAY LIMITED WARRANTY

Hy-Gain Electronics Corporation warrants all products manufactured by it and bearing Hy-Gain model numbers to be free from defective material and workmanship under normal use and service and agrees to repair such products, if investigation discloses the defect to be the fault of our manufacture. Hy-Gain's obligation under this warranty is limited to repairing any such product which, upon our examination, proves to be so defective. All products repaired under such warranty must be returned to the Hy-Gain Warranty Service Department or any authorized Hy-Gain service center, transportation prepaid by the purchaser, within ninety days from the date of purchase.

This warranty applies only to the original purchaser. Upon receipt of equipment, the buyer is responsible for checking the contents for damage. Any shipping damage should be referred to the carrier.

This warranty does not apply to any Hy-Gain products which have been repaired, worked on, or altered by persons not authorized by Hy-Gain to do so, or products to which the repair has injured the stability or reliability of such product, or which has been the subject of mis-use, negligence, or accident, or the serial number of which has been removed, altered, effaced, or in any other way rendered unidentifiable. Neither does this warranty apply to any of our products which have been connected, installed, used, or otherwise adjusted other than in accordance with instructions furnished by Hy-Gain. Nor does Hy-Gain assume any liability for consequential damages, and in any event, our liability shall not exceed the original purchase price of the product.

Accessories supplied by, but not manufactured by Hy-Gain, shall carry only such warranty as is available from the manufacturer of such goods and are specifically excluded from Hy-Gain warranties.

This warranty is void if Hy-Gain shall inspect equipment and find that it has been modified, or improperly installed or used. This warranty is expressly in lieu of all other warranties, expressed or implied, and all other obligations or liabilities on the part of Hy-Gain. No person, including any dealer, agent, distributor, or representative of Hy-Gain is authorized to assume for Hy-Gain any liability on its behalf, or in its name, except to refer purchasers to this warranty.

All claims of defect or shortage should be addressed to:

Hy-Gain Warranty Service Department  
4900 Superior Avenue  
Lincoln, Nebraska 68504

or to any authorized Hy-Gain service center.

You must mail the warranty card in immediately. Then, in making a claim, you need only furnish the model and serial numbers of the unit. However, if for some reason, the card was not mailed, a copy of a document, such as a sales receipt, recording the date, place and proof of purchase may, at the discretion of the service department, serve to establish your warranty. Your warranty claim letter should include all pertinent details, along with the part or item numbers involved. Do not return anything until requested to do so. You must supply the above information.

Any returned items must have prior authorization. Unexpected returns are greatly delayed in handling. These delays can be avoided by writing in advance furnishing the necessary information.

Hy-Gain reserves the right to make changes in design and improvements in its products without assuming any obligation to install the same on any of its previously manufactured products. Further, Hy-Gain reserves the right to ship new and/or improved products which are similar in form, fit, and function to the products originally ordered.

**### hy-gain DE PUERTO RICO**