

# User Manual

Solid-State HF/50MHz Band  
100W Linear Power Amplifier

Model HL-100BDX

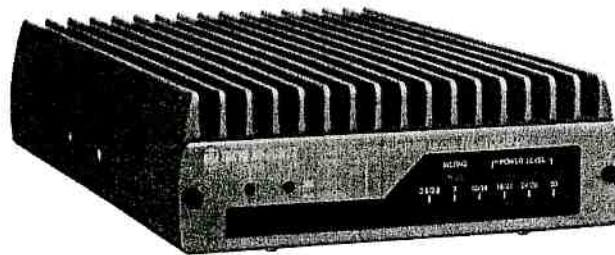

## ( 1 ) FEATURES

- HL-100BDX is a solid-state HF/50MHz band linear amplifier with the maximum output power of 100W. RF driving power is 5W or 10W ( Switch selectable on front panel ) This model is designed with popular portable radio FT-817 in mind. If combined with FT-817 , you can enjoy a unique and very comfortable feature of automatic band select by connecting the amp and radio with a supplied , special DIN plug cable. A pair of RD70HVF1 MOS FET RF power transistors, newly developed by Mitsubishi Electric are used in a broad band, push-pull form.
- Output low-pass filters are furnished for entire bands covering 3.5 through 50MHz. These filters suppress the undesired harmonics effectively.
- RF keying circuit ( or carrier operated send-receive switch ) is equipped. Consequently if you connect your transceiver and antenna to HL-100BDX, and supply DC power, you are on the air with mighty 100W output power. Also HL-100BDX has a socket for switching signal from transceiver to make combined send-receive switching with transceiver ( master/slave T/R switching ). The operation modes are SSB,CW, FM and AM.
- WARNING circuit is provided. When the improper band-setting and antenna short are detected, protection circuit works to avoid troubles. Reverse DC power polarity is also protected. WARNING lamp on front panel will light to indicate that protection has worked, while the PIC micro computer will alarm the nature of the trouble by Morse code tones.
- Optional \*external fan with mounting bracket can be installed for the better cooling of the heat-sink . DC power socket for fan is located at the rear panel. ( \* Optional external fan with mounting bracket : *HBK-110F* )
- LED power level meter will always indicate the output power level.
- ALC socket is available at the rear panel, from which negative DC voltage ( 0 to - 10V ) can be fed back to the transceiver ALC pin in order to keep the peak power within the maximum rating and /or to limit to certain level. This function is effective for obtaining a clean SSB/CW signal without the splatter.

## ( 2 ) SPECIFICATIONS

Frequency	:	HF Band ( 3.5 ~ 28 MHz and 50MHz.. Amateur Bands )
Mode	:	SSB, CW, FM ( *AM )
RF Drive Power	:	5W / 10W ( Switch select )
RF Output Power	:	100W ( 33W for AM )
In/Out Impedance (Zin/out)	:	50 ohms ( unbalanced )
Final RF Power Transistor	:	RD70HVF1 x 2 ( by Mitsubishi )
Amp. Circuitry	:	Class AB Push-pull
Major Circuits and Functions	:	① Output low-pass filters ( Band switch selected ) ② RF key circuit ( Carrier operated send/receive switch ) ③ WARNING ( Protection circuit for antenna open/short, band set error , DC power polarity error )
DC Power	:	DC 13.8V , 15A max.
In / Out connectors	:	Type SO – 239 ( or M – J )
Dimensions	:	174 x 56 x 235 mm ( WxHxD )
Weight	:	Approx. 2.4 kgs. ( 5.3 lbs.)
Accessory Parts	:	Mounting bracket with screws, DC power cord (Red/Black 1.2m or 4 feet , Coax jumper cable with “M-male” connectors 60cm (24 inches) long, Control cable for FT-817 with Yaesu special mini-DIN plug, 8 pin DIN plug, Fuse 20A x 2 .
Cooling Method	:	Natural Air Flow

### ( 3 ) Front and Rear Panels

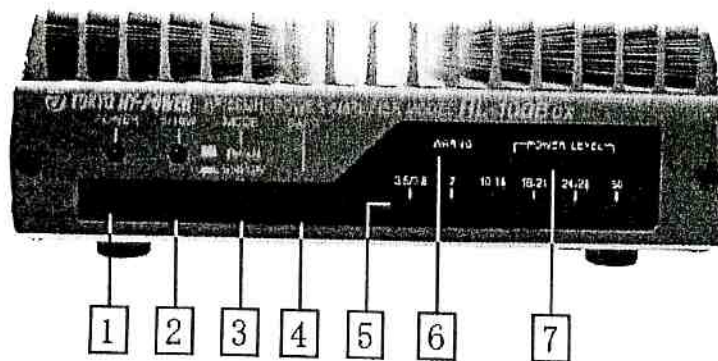

#### FRONT PANEL

- ① **POWER** : ON/OFF switch for DC power. When it is once pushed, the switch is locked for "ON". If it is pushed again, the lock will be reset for "OFF".
- ② **5W/10W ( RF Drive Power Select )** : If pushed , LED lamp above switch will light red to indicate 10W drive level has been selected. When pushed one more time, 5W level will be selected and lamp will go off. To work FT-817, select 5W. ( If 10W level is selected for FT-817, maximum output will be 50W, or one half of 100W. )
- ③ **MODE ( SSB,CW/ FM, AM )** : To select the time lag ( hold time ) of switching TX back to RX. If pushed, "SSB, CW" is selected, TX state will be held for half a second after finishing transmission. If pushed one more time, "FM, AM" will be selected for no time lag. This function is useful when your radio ACC socket is not connected with ACC socket of HL-100BDX. In other words, if the radio is connected to ACC socket of HL-100BDX, always select "FM, AM".
- ④ **BAND ( Manual Band Select Switch )** : As you press this button, BAND will be shifted to upper band. If you are not working the auto band select for FT-817, use this switch to select proper operating frequency band.
- ⑤ **BAND INDICATOR LAMP** : Lamp indicates the operating band.
- ⑥ **WARN'G. ( PROTECTION )** : When the protection circuit works, WARNG LED lamp will light. There are protections for RF over-drive, DC over voltage, antenna short, band set error and so forth. To reset, after checking the causes of troubles , push the ① POWER switch again.
- ⑦ **POWER LEVEL** : Five LED's indicate the transmitting power level. When all the lamps light, output level is 80 watts or over.

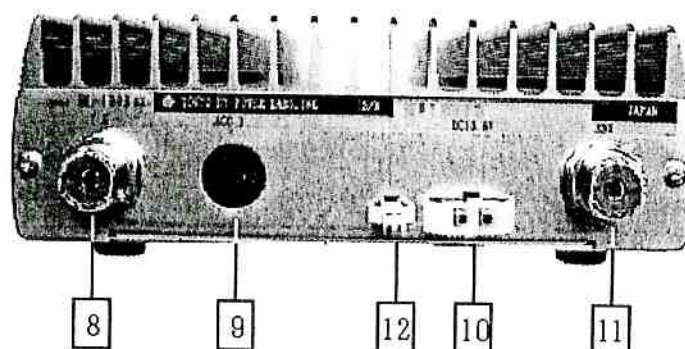

⑨ ACC ( Socket for connection with ACC/ Remote of transceiver )

Connect the control cable from the transceiver, such one as supplied for FT-817 as standard accessory. T-R switching, auto band switching, and ALC feed back will become feasible. For the radios other than FT-817, auto band switching is not achieved.

( See the "Typical Connection and Setting ( 4 )" that appears later. )

⑩ TX ( RF Input Connector ) : Connect the coaxial jumper cable from the transceiver "ANT".

⑩ DC 13.8V TERMINAL : Using the DC power cord supplied, connect to either regulated DC power supply, or DC 12V battery. RED is positive, and black is for negative. Current capacity should be 20A or more

⑪ ANT ( RF Out Connector ) : Connect the antenna cable. ( Or the cable from the POWER/SWR meter which may be placed between HL-100Bdx and antenna for swr check purpose. If you wish to install an antenna tuner ( manual or auto ), please place it between HL-100Bdx and the antenna ( or between SWR/METER and antenna ).

⑫ Socket for HBK-110F : Connect the connector from the HBK-110F ( optional mounting bracket with cooling fan) to supply DC 13.8V power for the fan. DC power needed for auto antenna tuner may be supplied from here ( 13.8V 1A max. ).

( 4 ) Typical Connection and Setting

For radios other than FT-817.

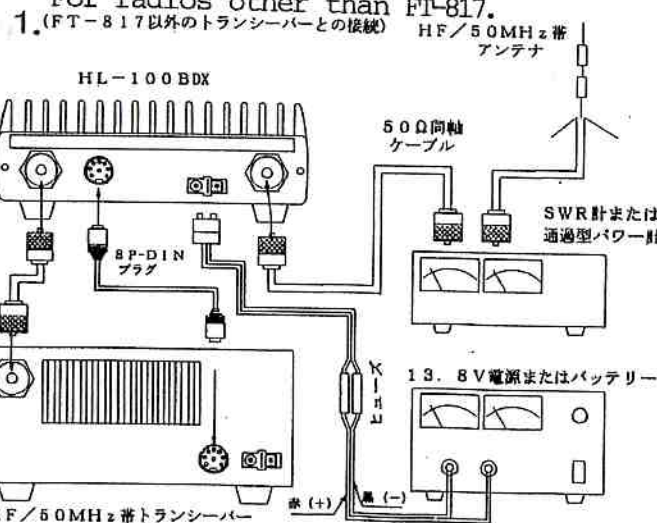

For FT-817 combination.

2. ( FT-817との接続 )

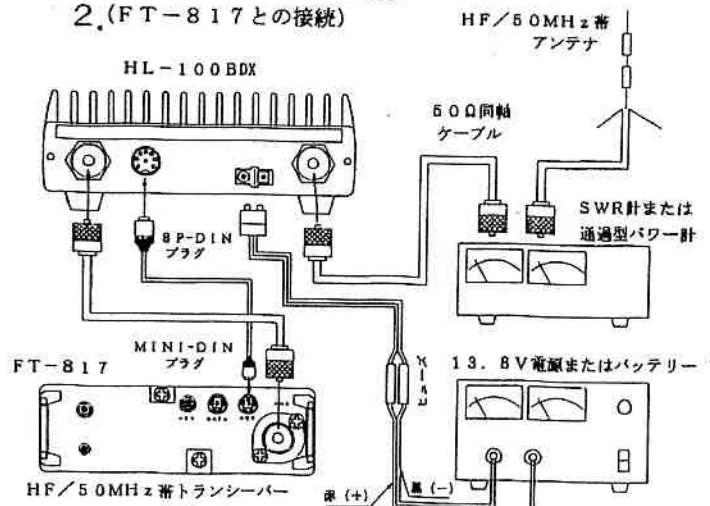

## ( 5 ) OPERATION

- ① Referring to the illustration, connect your transceiver, amp., and power supply (or battery), SWR/Power meter, antenna etc. properly. It is recommended that antenna is well adjusted for a good SWR value such as 1.5 or lower. If you place an auto antenna tuner between the radio and HL-100Bdx, it will mean nothing in the sense of achieving the better matching of antenna and power amplifier. Tuner should be always inserted between antenna and final RF power source.
- ② Set the Band Switch ④, if necessary, to the desired operating frequency band.
- ③ Checking that antenna system is correctly set, find the vacant frequency channel. Turn on the DC POWER switch ①.
- ④ If you key (transmit) the transceiver, HL-100Bdx amplifier will also be automatically keyed to transmit. Then the amplified signal is emitted from antenna. At this time, LED's of POWER LEVEL INDICATOR will light according to the transmitting signal level.
- ⑤ Depending on the transmission mode, set the MODE SELECT SWITCH to either SSB/CW or FM/AM. ( See " ③ MODE " in the Front and Rear Panels explanation. ) When HL-100Bdx is operated with rf key circuit ( carrier operated send-receive switching ) for ssb, TX state will be switched to RX, if you stop talking.
- ⑥ For the smooth and fast TX/RX switching, it is recommended that you will utilize ACC⑨ to connect to "Remote" or "ACC" socket of the transceiver.
- ⑦ When the amp. works heavily for a long time, heat sink may get heated. It is recommended that external cooling fan is applied over the heat sink.  
( For information, external cooling fan with mountain bracket "HBK-110F" is available as an optional parts. )
- ⑧ If you are going to operate without HL-100Bdx amplifier ( or "on bare-foot" ), leave the coaxial jumper cable connections as they are, and just turn off the power switch. And all the signals coming in and out of the antenna will by-pass the amplifier.
- ⑨ HL-100Bdx has a power gain of 20 (times), that means 20W output will be achieved if you connect a 1W output QRP transceiver. ( 10 times gain if 10W IN is selected on the front panel. )
- ⑩ If you would like to strictly control the peak output power within 100W or lower, you can utilize "ALC" by feeding ALC signal ( negative DC voltage varying with relation to voice or CW carrier ) back to "ALC pin" of the "ACC" socket of the radio. Details of connection and how to adjust ALC level will follow.

## ( 6 ) ACC SOCKET ( Accessory Socket )

Pin assignment of ACC socket is shown in the following table. You can connect the supplied control cable for FT-817 to this ACC socket. Or prepare a suitable control cable for your own radio using the supplied 8 pin DIN plug.

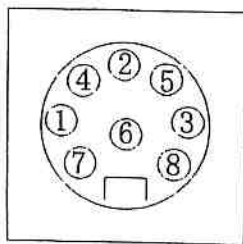

External View ( Viewed from outside of rear panel )

Pin #	SIGN	Description
①	STBY	When grounded, amp will become TX state.
②	+DC	When +DC (5-12V) applied, amp will become TX state.
③	AUTO	To receive band switching signal ( DC 0-5V max. )
④	N/C	No connection.
⑤	N/C	No connection.
⑥	GND	Ground terminal.
⑦	N/C	No connection.
⑧	ALC	ALC voltage ( negative DC ), to be fed back to radio, will appear.

## ( 7 ) ALC Pot Adjustment

If the output power of the radio is higher than 5W (and or 10W), over driving and its resulting higher output power can be suppressed with the proper adjustment of ALC circuit. Setting of ALC pot ( variable resistor, potentiometer ) requires a bit of learning and experience. Modern solid state ssb transceivers are well controlled within themselves as to amplification level control. ALC feed back may be neglected, as long as you talk to microphone modestly and you do not intentionally over drive the amplifier.

Negative DC voltage of 0V~8V max. will appear at pin ⑧ of ACC socket according to the amp output level. ALC feed back voltage required for the radio differs from radio to radio. FT-817 may require 7 to 8V, and IC-703 may need 4 to 5V. To adjust ALC level, look at the bottom plate for a small hole to access to the ALC adj. pot. When this pot is turned fully clockwise, ALC voltage becomes zero. If it is turned counter-clockwise, absolute DC voltage value for ALC will become higher and output power will start to decrease at some point.

To set the ALC pot, try to find the point where output level will start to decline. Referring to RF power meter, adjust the pot for 100W output. Or set the pot at the point where the output is just about to decrease.

( If you do not wish to apply any ALC, turn the pot clockwise fully and leave it there. )

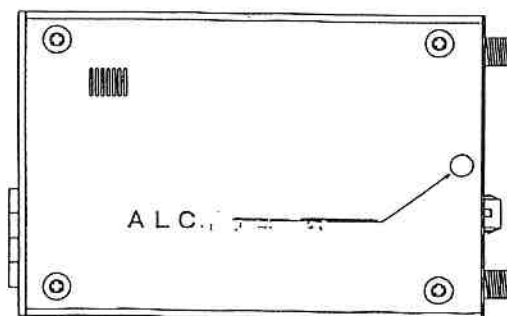

## ( 8 ) Protection

### 1. BAND ERROR

Band signal fed to pin ③ of ACC goes beyond 5V or the rated one for 50MHz, HL-100BDX will make alarm of BAND ERROR CW code ( Morse code ) will sound as shown in the following table of alarm tone.

### 2. Over Drive Protection

When the RF driving power from the radio exceeds 5W and or 10W, This amplifier will be in the through mode ( bypass ). WARNG LED lamp on the front panel will light and OVER DRIVE will be alarmed ( DRV ERR ).

### 3. ANTENNA SHORT/ BAND SET ERROR PROTECTION

When there is no output from antenna connector ( ANT ⑪ ), even if there is a driving power to this amplifier, HL-100BDX will become "bypass" state. WARNG LED will light and antenna error ( ANT ERR ) will be alarmed.

### 4. Over Voltage Protection

When the supplied DC power voltage exceeds 16V, this amplifier will become "bypass" state and WARNG LED will light. Also over voltage ( VOLT ERR ) will be alarmed.

## ( 9 ) Alarm Sound Table

Morse code Tone ( CW )	Nature of Error
BAND ERR	Band error ( Out of HF/6m )
DRV ERR	Overdriving ( RF )
VOLT ERR	Over voltage ( DC Power Supply )
ANT ERR	Antenna error



## ( 10 ) Cautions and Some Advice

1. The heat sink temperature may gradually become very high, as you keep transmitting. Do not put any thing on top of the heat sink, or ventilation will be degraded. Also do not place the power amplifier under the direct solar rays.
2. Refrain from operating with high SWR antenna, such as 2.0 or over. Tune the antenna well for lower SWR ( ideally 1.5 or lower ). Manual or auto antenna tuner may help achieve low SWR conditions. Antenna system must be solidly connected through good 50 ohm coaxial cable and connectors with IN / OUT terminals of HL-100BDX.
3. Do not exceed the rated RF input power level of 5W and/or 10W.
4. Rated DC power supply voltage is 13.8V . Higher voltage will give stress to the expensive RF power MOS FET's . Never apply AC 115V, or HL-100BDX will be seriously damaged at once.
5. There is a case when DC output voltage of regulated DC power supply swings up due to RF intrusion to inside control circuit of power supply. Choose the stable power supply for RF stray having current capacity of 15A continuous, and 20A peak capacity. Depending on SWR condition of your antenna system, there may appear some RF stray on the DC power cable connecting rear socket and DC power supply. If the voltage meter of your DC power supply shows an unstable performance as you key the radio and HL-100BDX amp., insert \*ferrite cores or clip both ends of DC power cable with \*\*clip-on ferrite cores. ( For further details, consult with your local radio dealer or amp manufacturer. ) ( \* , \*\* : Ferrite cores for RFI solution are available from Palomar Engineers , [www.Palomar-Engineers.com](http://www.Palomar-Engineers.com) or from Amidon Associates. )

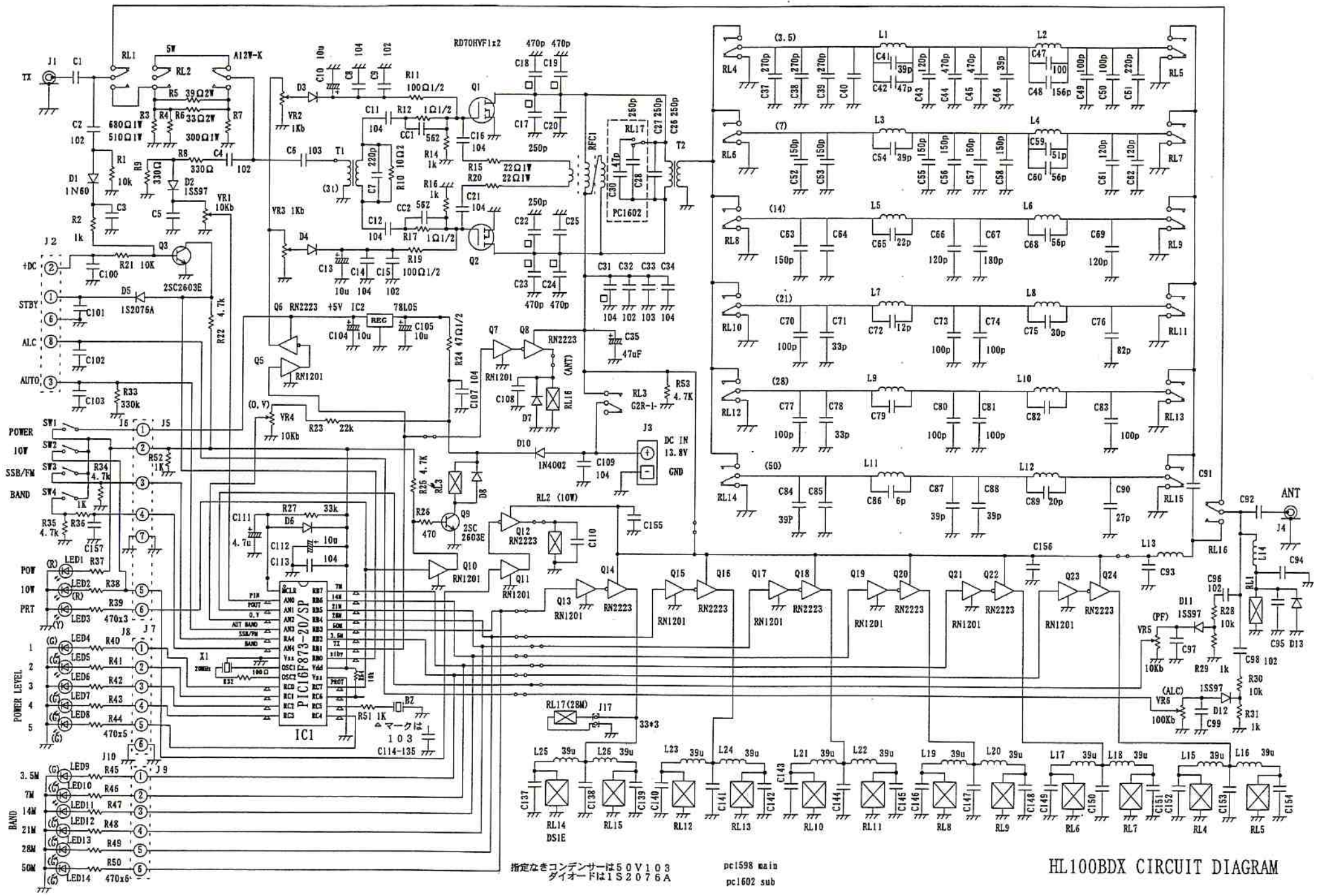

指定なきコンデンサは50V 103  
ダイオードは1S2076A

pc1598 main  
pc1602 sub

HL100BDX CIRCUIT DIAGRAM